



UNIVERSIDADE FEDERAL DE SANTA CATARINA
CENTRO TECNOLÓGICO
PROGRAMA DE PÓS-GRADUAÇÃO EM ENGENHARIA QUÍMICA

Maikon Kelbert

Antineoplastic drugs: Effect of doxorubicin on enriched archaea culture from anaerobic digestion and potential degradation via an enzymatic process

Florianópolis

2022

Maikon Kelbert

Antineoplastic drugs: Effect of doxorubicin on enriched archaea culture from anaerobic digestion and potential degradation via an enzymatic process

Tese submetida ao Programa de Pós-Graduação em Engenharia Química da Universidade Federal de Santa Catarina para a obtenção do título de Doutor em Engenharia Química
Orientador: Prof. Dr. Hugo Moreira Soares.
Coorientadora: Prof.^a Dr.^a Camila Michels.

Florianópolis

2022

Ficha de identificação da obra elaborada pelo autor,
através do Programa de Geração Automática da Biblioteca Universitária da UFSC.

Kelbert, Maikon
Antineoplastic drugs: Effect of doxorubicin on enriched
archaea culture from anaerobic digestion and potential
degradation via an enzymatic process / Maikon Kelbert ;
orientador, Hugo Moreira Soares, coorientadora, Camila
Michels, 2022.
129 p.

Tese (doutorado) - Universidade Federal de Santa
Catarina, Centro Tecnológico, Programa de Pós-Graduação em
Engenharia Química, Florianópolis, 2022.

Inclui referências.

1. Engenharia Química. 2. Poluentes emergentes . 3.
Tratamento de efluentes. 4. Toxicidade em microrganismos.
5. Degradação enzimática. I. Moreira Soares, Hugo . II.
Michels, Camila . III. Universidade Federal de Santa
Catarina. Programa de Pós-Graduação em Engenharia Química.
IV. Título.

Maikon Kelbert

Antineoplastic drugs: Effect of doxorubicin on enriched archaea culture from anaerobic digestion and potential degradation via an enzymatic process

O presente trabalho em nível de doutorado foi avaliado e aprovado por banca examinadora composta pelos seguintes membros:

Prof.^a Andréa Lima dos Santos Schneider, Dr.^a
Universidade da região de Joinville

Prof.^a Débora de Oliveira, Dr.^a
Universidade Federal de Santa Catarina

Prof.^a Rejane Helena Ribeiro da Costa, Dr.^a
Universidade Federal de Santa Catarina

Certificamos que esta é a **versão original e final** do trabalho de conclusão que foi julgado adequado para obtenção do título de doutor em Engenharia Química.

Prof.^a Débora de Oliveria, Dr.^a
Coordenação do Programa de Pós-Graduação

Prof. Hugo Moreira Soares, Dr.
Orientador

Florianópolis, 2022.

Dedico esse trabalho a minha mãe Inez J. Kelbert, meu pai Waldir Kelbert, minha irmã Kely D. Kelbert e também à um pequeno garoto, que quando criança, sonhava em ser cientista.

AGRADECIMENTOS

Minha mais profunda gratidão à minha mãe, meu pai e minha irmã por sempre apoiarem as minhas decisões, acreditarem incondicionalmente em mim e se sacrificarem para que eu pudesse chegar até aqui. Essa conquista não é minha, é nossa!

Às minhas tias Helga e Ingrid, a minha prima Barbara e a minha avó Else por serem essas pessoas tão magníficas. Você me ajudaram a entender que o mundo é muito menor do que uma criança que cresceu no interior poderia imaginar.

Em especial, ao Professor Hugo Moreira Soares e a Professora Camila Michels pelas orientações, ensinamentos e amizade. Agradeço também pela oportunidade que me foi dado de fazer doutorado sanduiche nos Países Baixos.

Agradeço muito a minha amiga e aluna de iniciação científica Adrielle, foram muitos dias de trabalho árduo e dificuldades, mas acima de tudo, foram muitos dias de alegria e risadas.

Agradeço Às minhas amigas Camilinha e a Naionara, juntos formamos um trio e tanto, dias de luta, dias de surtos e dias de glória.

Aos membro e ex-membros do Laboratório de Engenharia Ambiental (e-biotech) Allison, Rayane, Elis, Maick, Bruna, Héric, Karen, Ana, Jamile e Dhiozer pelas contribuições dadas no trabalho e por proporcionarem dias de aprendizado e risadas durante essa trajetória.

Agradeço a minha amiga Karina por estar sempre disposta ajudar, por discutir os experimentos e resultados, por me acompanhar nas noites de estudo e acima de tudo pelos anos de amizade.

À Professora Débora de Oliveira por todos os ensinamentos e amizade durante o decorrer do mestrado e doutorado, você é uma inspiração para todos nós!

Um agradecimento especial ao Professor Jules van Lier e Professora Merle de Kreuk por abrir as portas do seu laboratório na Holanda e ter me dado a oportunidade de conhecer um novo mundo na pesquisa.

A todos os amigos que tive a oportunidade de conhecer na Holanda em especial ao Sebas, Lais, Javier, Raquel, Hamed, Zoe, as Dianas, Antonia, João, Nan, Miao e Daniel.

Aos meus queridos amigos Alexandre, Bruna, Carol, Emerson, Felipe e Gabriel. Os cafés, tardes de conversa e risadas, baladas e noites de jogos com vocês me fazem levar a vida com mais leveza e alegria.

Agradeço ao meu amigo Amurabi por toda a ajuda e motivação durante toda essa etapa.

Aos amigos Aloia, Eduardo, Lucília e Francisco por todos os diversos conselhos, aprendizado e amizade, sem dúvida não seria quem sou se vocês não tivessem passado por minha vida.

Aos inúmeros amigos que participaram de alguma forma para que eu pudesse concluir essa etapa da minha vida, em especial a Emily, Fabricio, Valdir e Eliza.

Às minhas orientadoras de iniciação científica Andrea, Ana Paula, Giannini e Michele. Foi graças a vocês que tive o primeiro contato com a pesquisa, me proporcionando um grande aprendizado e me inspirando a realizar o mestrado e doutorado.

Aos membros da banca por aceitarem avaliar este trabalho e pelas contribuições dadas.

À Universidade Federal de Santa Catarina e ao Programa de Pós-Graduação em Engenharia Química por todos os recursos disponibilizados. Ao Laboratório Central de Microscopia Eletrônica da Universidade Federal de Santa Catarina (LCME/UFSC) pelas análises de microscopia confocal. Ao Laboratório Multiusuário de Estudos em Biologia (LAMEB) pela disponibilidade da balança analítica de alta precisão. Ao CNPq e CAPES pelo apoio financeiro, em especial ao programa PRINT-CAPES pela bolsa de doutorado sanduiche.

Agradeço a todos os amigos que de maneira indireta deixaram sua marca e me fizeram ser quem sou hoje, como diz o autor Antoine de Saint-Exupéry em seu livro O Pequeno príncipe: *“Aqueles que passam por nós, não vão sós, não nos deixam sós. Deixam um pouco de si, levam um pouco de nós”*.

Obrigado!

“O futuro não é um lugar onde estamos indo, mas um lugar que estamos criando. O caminho para ele não é encontrado, mas construído e o ato de fazê-lo muda tanto o realizador quanto o destino.”

(Antoine de Saint-Exupéry)

RESUMO

Fármacos antineoplásicos vem sendo detectados em efluentes e águas superficiais. Devido a sua toxicidade, estes fármacos apresentam grande risco ao meio ambiente, mesmo em baixas concentrações. Sabe-se que estes não são removidos completamente pelo sistema convencional de tratamento de efluentes. Deste modo, o desenvolvimento de novas estratégias para a sua remoção são cruciais. Enzimas como a lacase apresentam grande potencial para degradar diversos poluentes, devido a não especificidade pelo substrato. Além disso, os produtos de degradação gerados por uma degradação enzimática apresentam menor toxicidade em comparação com as moléculas originais. Também não se sabe ao certo como estes fármacos influenciam a comunidade microbiana presente em uma estação de tratamento de efluentes. Alguns grupos de microrganismos representam papel chave no tratamento de efluentes. Por exemplo, as arqueas metanogênicas (que compõem a última etapa da digestão anaeróbica), se estas forem inibidas o processo com um todo será comprometido. Neste sentido, este trabalho tem como objetivo estudar o potencial efeito inibitório do fármaco antineoplásico doxorubicina em arqueas metanogênicas, assim como avaliar o potencial de aplicação da lacase na degradação destes fármacos. Para isso, o efeito inibitório da doxorubicina sobre a produção de biogás foi avaliado em ensaios de exposição em batelada e em longo prazo. Nos ensaios em batelada, o valor de IC_{50} de $648 \pm 50 \mu\text{g}\cdot\text{L}^{-1}$ foi obtido para a doxorubicina. Além disso, verificou-se que a inibição causada pela exposição a $10 \times 10^3 \mu\text{g}\cdot\text{L}^{-1}$ foi reversível após subsequentes bateladas sem a presença do fármaco no meio e alimentação. A doxorubicina foi rapidamente adsorvida pela biomassa (apesar do baixo K_{OW}), o que pode ter contribuído para o efeito inibitório sobre os microrganismos. Os resultados dos ensaios de exposição de longo prazo mostraram que quando a quantidade do fármaco foi aumentada de $100 \mu\text{g}\cdot\text{L}^{-1}\cdot\text{dia}^{-1}$ para $200 \mu\text{g}\cdot\text{L}^{-1}\cdot\text{dia}^{-1}$, a produção de biogás e a remoção da carga orgânica diminuíram drasticamente. No entanto, as archaeas metanogênicas foram capazes de se adaptar à condição inibitória, corroborando os resultados encontrados nos ensaios em bateladas sequenciais. Em suma, a doxorubicina pode desempenhar um papel fundamental na inibição de processos de tratamento biológico de efluentes, se sua concentração em estações de tratamento aumentarem abruptamente. Os ensaios de exposição à doxorubicina mostraram que esta pode inibir a velocidade de produção de biogás. Desta forma, decidiu-se estudar a degradação desse fármaco por via enzimática. A lacase proveniente de *Trametes versicolor* foi utilizada para realização

dos estudos cinéticos de degradação. A citotoxicidade do fármaco degradado pela lacase foi avaliada e comparada com a doxorrubicina in natura. As melhores condições de degradação foram em pH 7 e em 30°C, o que se assemelha a parâmetros operacionais de estações de tratamento de efluentes. Os parâmetros cinéticos de Michaelis–Menten foram v_{max} de 769,2 $\mu\text{g}\cdot\text{h}^{-1}\cdot\text{L}^{-1}$ e K_M de 4,60 μM indicando uma boa afinidade pelo substrato. Já os ensaios de citotoxicidade demonstraram que a lacase reduziu a toxicidade da doxorrubicina, após degradação, apresentando potencial para aplicação na degradação de fármacos antineoplásicos presentes em efluentes, o que abre novos horizontes para estudos sobre o tema.

Palavras-chave: Arqueas metanogênicas. Digestão anaeróbica. Fármacos antineoplásicos. Antraciclinas. Quimioterápicos. Oxidorredutases. Degradação enzimática.

RESUMO EXPANDIDO

INTRODUÇÃO

Nos últimos anos, vários estudos vêm demonstrando que processos biológicos de tratamento de efluentes não são capazes de remover completamente alguns fármacos (COETSIER *et al.*, 2009; TERNES *et al.*, 1998; VERLICCHI *et al.*, 2012). Esses fármacos, assim como seus metabólitos, são detectados em águas superficiais em concentrações que podem variar desde nanogramas até microgramas por litro (COETSIER *et al.*, 2009; NEGREIRA; DE ALDA; BARCELÓ, 2014). Dentre esses produtos farmacêuticos, podemos citar os fármacos antineoplásicos. Estes vêm ganhando enfoque devido ao seu elevado nível de toxicidade, acrescido à dificuldade de remoção destes através de sistemas convencionais de tratamento de efluentes (FRANQUET-GRIELL *et al.*, 2017; OLALLA *et al.*, 2018).

Em microrganismos, o conhecimento sobre os mecanismos de ação de fármacos antineoplásicos são praticamente inexistentes. Contudo, estes atuam, em sua maioria, diretamente no DNA, geram apreensão em torno do seu potencial em inibir a atividade de comunidades biológicas presentes em estações de tratamento de efluentes (ETE) (ZHANG *et al.*, 2013, SANTANA-VIERA *et al.*, 2016). A remoção de matéria orgânica pode ser realizada por processos aeróbios ou anaeróbios. No que diz respeito a processos anaeróbios, a digestão anaeróbia é uma alternativa interessante para aplicação em sistemas de tratamento descentralizados (CREMONEZ *et al.*, 2021), como hospitais. A digestão anaeróbica ocorre em quatro etapas, sendo elas a hidrólise, acidogênese, acetogênese e metanogênese. Dentre estas etapas, a metanogênese é o foco em diversos estudos de inibição, uma vez que é considerada uma etapa limitante do processo (STEINMETZ, 2016). Fatores ambientais como pH, temperatura, salinidade e até mesmo a presença de substâncias (um função da concentração), como fármacos, ácidos voláteis e compostos fenólicos, podem inibir a atividade destes microrganismos (LEE; KIM; HWANG, 2021).

Por apresentarem elevada recalcitrância e possuírem potencial inibitório para comunidades microbianas de ETE, se faz necessário a aplicação de estratégias alternativas para remoção de fármacos antineoplásicos. Estudos recentes demonstram a eficácia de fungos da podridão branca para remoção de alguns fármacos anticâncer (FERRANDO-CLIMENT *et al.*, 2015). Esta remoção é atribuída a atuação de enzimas extracelulares, em especial a lacase (CASTELLET-ROVIRA *et al.*, 2018). Devido a sua não especificidade pelo substrato, a lacase apresenta grande potencial para degradação destes. O primeiro artigo de revisão falando sobre

o potencial de aplicação de lacase para remoção destes fármacos foi publicado por Pereira *et al.* (2020), membro do Laboratório de Biotecnologia Ambiental (e-biotech / UFSC) e mais tarde, uma dissertação de mestrado na área foi defendida pela mesma (PEREIRA, 2020), apontando novas direções para a aplicação de lacase no tratamento de efluentes.

OBJETIVO

A tese se propõe a avaliar o efeito do fármaco antineoplásico doxorubicina (DOX) sobre a digestão anaeróbia utilizando uma cultura enriquecida de arqueas provenientes de uma estação de tratamento de efluentes e propor um método alternativo para a remoção de fármacos anticâncer utilizando enzimas livres.

METODOLOGIA

Para realização dos ensaios de inibição, foi utilizada uma cultura mista enriquecida de arqueas metanogênicas. Ensaios de exposição em batelada foram conduzidos em frascos de penicilina com inóculo de $2 \text{ gvss} \cdot \text{L}^{-1}$, alimentados com meio sintético com carga orgânica de $1 \text{ g}_{\text{COD}} \cdot \text{L}^{-1}$, nas concentrações de doxorubicina variando de 0,05 a $10 \text{ mg} \cdot \text{L}^{-1}$. As variáveis resposta foram a quantidade de biogás produzida e a velocidade de produção de biogás, medidas diariamente utilizando uma seringa de vidro graduada. Em seguida foram realizados ensaios em batelada sequencial, utilizando as condições experimentais que mostraram inibição na produção de biogás na etapa anterior. Esses experimentos foram conduzidos por 3 ciclos sequenciais de 13 dias cada, sendo o primeiro com exposição a doxorubicina, e os dois posteriores sem exposição a doxorubicina, e a produção de biogás foi medida diariamente. O efeito da sorção do fármaco na biomassa foi avaliado utilizando a biomassa inativada por processo de autoclavagem. Por fim, a exposição contínua da biomassa à doxorubicina foi conduzido por 110 dias. Os experimentos foram conduzidos em 5 fases, sendo:

- I) De 0 a 10 dias: alimentação de $0,2 \text{ g}_{\text{COD}} \cdot \text{L}^{-1} \cdot \text{dia}^{-1}$ sem a presença de doxorubicina;
- II) De 10 a 30 dias: alimentação de $0,2 \text{ g}_{\text{COD}} \cdot \text{L}^{-1} \cdot \text{dia}^{-1}$ e $100 \text{ } \mu\text{g}_{\text{DOX}} \cdot \text{L}^{-1} \cdot \text{dia}^{-1}$ de doxorubicina;
- III) De 30 a 40 dias: alimentação de $0,4 \text{ g}_{\text{COD}} \cdot \text{L}^{-1} \cdot \text{dia}^{-1}$ e $100 \text{ } \mu\text{g}_{\text{DOX}} \cdot \text{L}^{-1} \cdot \text{dia}^{-1}$ de doxorubicina;
- IV) De 40 a 90 dias: alimentação de $0,4 \text{ g}_{\text{COD}} \cdot \text{L}^{-1} \cdot \text{dia}^{-1}$ e $200 \text{ } \mu\text{g}_{\text{DOX}} \cdot \text{L}^{-1} \cdot \text{dia}^{-1}$ de doxorubicina;
- V) De 90 a 110 dias: alimentação de $0,4 \text{ g}_{\text{COD}} \cdot \text{L}^{-1} \cdot \text{dia}^{-1}$ e $100 \text{ } \mu\text{g}_{\text{DOX}} \cdot \text{L}^{-1} \cdot \text{dia}^{-1}$ de doxorubicina.

Os experimentos foram conduzidos em frasco de 50 mL com inóculo de 2 gVSS·L⁻¹. As variáveis resposta foram a produção de biogás, consumo de DQO, concentração de doxorubicina no efluente e abundância relativa da comunidade microbiana.

Na segunda parte do trabalho a lacase, proveniente de *Trametes versicolor*, foi utilizada para realização dos estudos cinéticos de degradação da doxorubicina. Os ensaios foram conduzidos em placa de 96 poços, e a doxorubicina foi quantificada por espectroscopia de fluorescência nos comprimentos de excitação e emissão de 480 e 598, respectivamente. A influência da concentração de lacase (450, 900 e 1800 U·L⁻¹) foi avaliada na degradação de doxorubicina na concentrações de 50, 250 e 500 µg·L⁻¹, os experimentos foram conduzidos no pH 6 a 30 °C. Objetivando-se determinar condições ótimas para degradação de doxorubicina, ensaios de variação de pH foram realizados na faixa de 3 a 8, e temperatura de 30 °C. Após determinado o pH ótimo de degradação, ensaios de variação de temperatura foram realizados nas temperatura de 20, 30 e 40 °C. Os parâmetros cinéticos de Michaelis-Menten (K_M and v_{max}), para a degradação da doxorubicina, foram determinados variando concentrações do fármaco de 0,25 a 10 mg·L⁻¹, no pH e temperatura ótimos obtidos nas etapas anteriores. Por fim, a citotoxicidade dos produtos de degradação do fármaco pela lacase foi avaliada em linhagem celular de L-929 e comparada com a doxorubicina não degradada.

RESULTADOS E DISCUSSÃO

O efeito inibitório da doxorubicina (capítulo 3), sobre a produção de biogás nos ensaios em batelada, demonstraram que em concentrações partindo de 500 µg·L⁻¹ ocorre inibição da atividade microbiana, sendo o valor de IC₅₀ de 648 ± 50 µg·L⁻¹ de doxorubicina. Além disso, com os resultados obtidos dos ensaios de batelada sequencial, verificou-se que a inibição causada pela exposição de 10 × 10³ µg·L⁻¹ de doxorubicina foi reversível após a remoção do meio sintético de alimentação (segundo ciclo). A produção de biogás normalizou após 2 ciclos, de 13 dias cada, sem a presença do fármaco. Além disso, a sorção da doxorubicina pela biomassa ocorreu rapidamente (apesar do baixo K_{OW}), indicando que interações eletrostáticas podem ser responsáveis por essa sorção e que o fármaco sorvido pode contribuir para o efeito inibitório obtido. Os resultados dos ensaios de exposição de longo prazo mostraram que quando a quantidade de doxorubicina foi aumentada de 100 µg·L⁻¹ ·dia⁻¹ para 200 µg·L⁻¹ ·dia⁻¹, a produção de biogás e a remoção de DQO diminuiram rapidamente. No entanto, as archaeas metanogênicas recuperaram-se da inibição, corroborando os resultados encontrados em ensaios de exposição em batelada sequencial. Os resultados de sequenciamento

mostraram que 84,44% da abundância relativa das amostras foi composta por archaeas e apenas 15,56% por bactérias. E dentre as archaeas os gêneros *Methanosaeta* e *Methanobacterium* foram mais abundantes, 63.01 e 21.4% respectivamente. Os resultados também sugerem simbiose entre as bactérias do gênero *Clostridium* e *Mesotoga* com as archaeas, principalmente do gênero *Methanobacterium*.

A degradação da doxorubicina pela lacase (Capítulo 4) foi realizada em diferentes atividades enzimáticas, valores de pH e temperaturas demonstraram que a melhor condição de degradação foi em pH 7 a 30 °C, o que se assemelha a parâmetros de efluentes oriundos de estações de tratamento de efluentes. Os parâmetros cinéticos de Michaelis–Menten foram v_{max} de 769,2 $\mu\text{g}\cdot\text{h}^{-1}\cdot\text{L}^{-1}$ e K_M de 4,60 μM o que mostrou uma boa afinidade pelo substrato. A citotoxicidade em linhagem celular L-929, demonstrou que a solução de doxorubicina degradada pela lacase não apresentou redução da viabilidade celular até a concentração de 250 $\mu\text{g}\cdot\text{L}^{-1}$. Em contraste, o controle com doxorubicina mostrou uma redução de 27% na viabilidade celular. Além disso, na maior concentração testada (1000 $\mu\text{g}\cdot\text{L}^{-1}$), a degradação reduziu em até 41,4% a toxicidade da doxorubicina, indicando que a lacase degrada a doxorubicina em compostos menos tóxicos.

CONSIDERAÇÕES FINAIS

Os resultados apresentados permitiram o entendimento de como o fármaco antineoplásico doxorubicina pode afetar uma comunidade microbiana de uma ETE. A exposição de curta duração de archaeas ao fármaco mostrou que este apresenta potencial para inibir esse grupo de microrganismos. A sorção da doxorubicina na biomassa pode contribuir para o efeito inibitório. Apesar do baixo K_{ow} presente pelo DOX, a sorção da biomassa pode ocorrer por interações eletrostáticas. O valor de IC_{50} de $648 \pm 50 \mu\text{g}\cdot\text{L}^{-1}$ da DOX foi obtido nos ensaios em batelada. Contudo, se o fármaco for removido do meio de alimentação, as archaeas podem recuperar sua atividade rapidamente, sugerindo que o mecanismo de inibição não está relacionado à morte dos microrganismos. No que se refere ao experimento de longa duração, observou-se que os microrganismos têm a capacidade de recuperar o processo após um período de adaptação. Finalmente, os principais gêneros de archaeas encontrados na biomassa foram *Methanosaeta* e *Methanobacterium*, enquanto o gênero *Mesotoga* foi a bactéria mais abundante.

A degradação da doxorubicina pela lacase foi aqui descrita pela primeira vez, com foco na aplicação para remoção desses fármacos de efluentes. Como hipotetizado, o presente trabalho demonstrou que lacase degrada o fármacos em todas as concentrações testadas. A

concentração de enzima foi inversamente proporcional ao tempo de degradação. Porém, a velocidade de específica de degradação diminuiu quando a concentração de enzima foi aumentada, o que indica que não é necessário adicionar grande quantidade de enzima para catalisar a reação. As condições ótimas para a degradação da doxorubicina (pH e temperatura) foram semelhantes às encontradas em efluentes de ETE, tornando-se uma aplicação interessante para a degradação de efluentes de hospitais ou indústrias. É importante ressaltar que os produtos de degradação do fármaco apresentaram menor citotoxicidade quando comparada a doxorubicina. Em suma, a lacase apresenta potencial para ser usado em uma nova estratégia para remover fármacos antineoplásicas de efluentes.

ABSTRACT

Antineoplastic drugs have been detected in effluents and surface waters. Due to their toxicity, these drugs present a high risk to the environment, even at low concentrations. In addition, it is known that the conventional wastewater treatment system does not completely remove these drugs. Thus, it is crucial the development of new strategies for their removal. Enzymes such as laccase have a great potential to degrade several pollutants due to their non-specificity for the substrate. Besides, the degradation products generated by an enzymatic degradation show less toxicity compared with the original molecule. Furthermore, it is unknown how these drugs influence the microbial community from a wastewater treatment plant. Some groups of microorganisms play a key role in effluent treatment. For example, the whole process will be compromised if microorganisms such as methanogenic archaea are inhibited (which constitutes the last step of anaerobic digestion). In this sense, the main objective of this thesis is to study the inhibitory effect of the antineoplastic drugs doxorubicin on methanogenic archaeas and evaluate the potential application of enzymes (more specifically laccase) in the degradation of these drugs. For this, the inhibitory effect of doxorubicin on biogas production was evaluated in batch and long-term exposure assays. An IC_{50} value of $648 \pm 50 \mu\text{g}\cdot\text{L}^{-1}$ was obtained for doxorubicin in batch assays. Besides, it was found that the inhibition caused by exposure to $10 \times 10^3 \mu\text{g}\cdot\text{L}^{-1}$ was reversible after subsequent batches without the drug in the synthetic medium. Doxorubicin was rapidly adsorbed by biomass (despite the low K_{OW} value), which may have contributed to the inhibitory effect on microorganisms. The long-term exposure assays showed that when the amount of drug was increased from $100 \mu\text{g}\cdot\text{L}^{-1}\cdot\text{day}^{-1}$ to $200 \mu\text{g}\cdot\text{L}^{-1}\cdot\text{day}^{-1}$, the biogas production and COD removal drastically decreased. However, the methanogenic archaeas were able to adapt to the inhibitory condition, corroborating the results found in the sequential batch tests. In summary, doxorubicin can play a key role in inhibiting biological processes if its concentration in wastewater treatment plants increases abruptly. Doxorubicin exposure trials have shown that it can inhibit the biogas production rate. Therefore, it was decided to study the enzymatic degradation of this drug. The laccase from *Trametes versicolor* was used to carry out the kinetic degradation studies. The cytotoxicity of the degraded doxorubicin (by laccase) was evaluated and compared to doxorubicin. The best degradation conditions were at pH 7 and 30°C, which resembles effluent characteristics from wastewater treatment plants. The Michaelis–Menten kinetic parameters were V_{max} of $769.2 \mu\text{g}\cdot\text{h}^{-1}\cdot\text{L}^{-1}$ and K_M of $4.60 \mu\text{M}$, which showed a good affinity for the substrate. Cytotoxicity showed that laccase reduces the toxicity of doxorubicin after degradation. Laccase

presents potential for application for degradation of effluents that contain antineoplastic drugs
opens new directions for studies on the subject.

Keywords: Methanogenic archaea. Anaerobic digestion. Anticancer drugs. Anthracyclines.
Chemotherapy drugs. Oxidoreductases. Enzymatic degradation.

LIST OF FIGURES

CHAPTER 1, 2, 3, 4 and 5

Figure 1. Simplify the scheme of a conventional wastewater treatment plant. The blue arrow is the water flow, and the brown arrow represents the solid flow.	31
Figure 2. Ecotoxicological impact of anticancer on aquatic animal. A) Gut of a tadpoles exposure to cyclophosphamide and 5-fluorouracil (red arrow indicate the malignant cell transformation processes). B) Zebrafish embryos exposure to vincristine, red arrows indicate the pericardial area; E indicate eye; PC is pericardial cavity; S is spine; T, is tail; TT is tail tip; YS is yolk sac.....	33
Figure 3. The research questions of the thesis.....	34
Figure 4. Conceptual diagram of the thesis showing the problem and motivation, thesis structure, what was evaluated in each experimental chapter, and deliverables.	36
Figure 5. Perspectives of cancer incidence.....	40
Figure 6. Emission sources of anticancer drugs	41
Figure 7. Representative scheme of anaerobic digestion steps: hydrolysis, acidogenesis, acetogenesis, and methanogenesis.	49
Figure 8. White-rot fungi from the species <i>Pleurotus ostreatus</i>	52
Figure 9. Mechanisms of drugs removal and/or degradation by white-rot fungi.....	53
Figure 10. Scheme demonstrating substrate oxidation by laccase from <i>Trametes Versicolor</i> with crystallographic structure obtained from Protein Data Bank (PDB ID: 1KYA).....	56
Figure 11. Biogas production yield for exposure to several doxorubicin concentrations.	66
Figure 12. Correlation between the percentage of inhibition of the enriched mixed culture and the concentration of doxorubicin.....	68
Figure 13. The biogas production after short-term exposure to DOX or without DOX in three operational cycles. 1 ^o cycle: short-term exposure to DOX; 2 ^o cycle and 3 ^o cycle: resuspended biomass without DOX.	69
Figure 14. Doxorubicin sorption to the inactivated biomass. A) kinetic sorption and hydrolysis, B) bright field microscopy image of the biomass, and C) fluorescence microscopy image of DOX sorbed into the biomass.	71
Figure 15. Effect of DOX on methanogenesis during a long-term experiment: A) Biogas production yield; B) COD removal; and C) Measurement of DOX in the influent and effluent.....	73

Figure 16. Relative abundance of the samples after DOX exposure at day 110 on A) domain and B) genus level. The average of >0.5% of relative abundance are shown.....	75
Figure 17. Graphical abstract of the chapter 4.....	79
Figure 18. Variation of laccase (LC) concentrations, where (■) without LC, (●) 450 U·L ⁻¹ , (▲) 900 U·L ⁻¹ and (▼) 1800 U·L ⁻¹ , to degrade doxorubicin (DOX) at the concentrations of A) 50 µg·L ⁻¹ , B) 250 µg·L ⁻¹ and C) 500 µg·L ⁻¹ . All degradations were carried out at pH 6 and 30 °C.....	87
Figure 19. Degradation of doxorubicin by laccase at different pH values. Degradations were carried out at 30 °C, with 250 µg·L ⁻¹ of DOX, and 900 U·L ⁻¹ of LC.....	89
Figure 20. Degradation of doxorubicin by laccase at different temperatures. Degradations were carried out at pH 7 with 250 µg·L ⁻¹ of DOX and 900 U·L ⁻¹ of LC.....	91
Figure 21. Relationship between initial degradation rates and doxorubicin concentration to determine the kinetic parameters. All degradations were carried out at 30 °C, pH 7 and 900 U·L ⁻¹ of laccase.	92
Figure 22. Cell viability of L-929 cells after 24 hours of exposure to doxorubicin (DOX) and doxorubicin degradation products (DOX-DP) by laccase. Indicated points on the graph by (*) are values statistically significant (p <0.05) related to the control.	94
Figure 23. Representation of several enzymatic reactors using membranes to allow enzyme reuse.....	99
Figure 24. A suggestion of applying enzymes as a polishing treatment using an enzymatic membrane reactor.	99
Figure 25. Plant-wide model of a WWTP using THP reactor.....	101

SUPPLEMENTARY MATERIAL

Figure S1. Illustrative scheme of the reactor used for acclimatization of the biomass used in the experiments. (A) represents the feed medium, (B) peristaltic pump, (C) reactor feed input, (D) output for the removal of biomass to carry out the experiments, (E) input and output of the reactor heating jacket , (F) three-phase separator, (G) reactor liquid outlet, (H) breather bottle and (I) gas meter.....	124
Figure S2. Monitoring of biogas production and biomass acclimatization reactor pH.....	125
Figure S3. Calibration line for the quantification of DOX.....	126

Figure S4. Values of pH in the effluent of the reactor during the log-term exposure assay to doxorubicin.....	126
Figure S5. Calibration line made in different pH values for the quantification of DOX. A) pH 3, B) pH 4, C) pH 5, D) pH 6, E) pH 7 and F) pH 8.	127
Figure S6. Calibration line for quantification of DOX, used in the experiments to determine Michaelis-Menten kinetic parameters.	128
Figure S7. Control experiments of DOX without the presence of LC in different pH values. All control experiments were carried out at 30 °C, with 250 µg·L ⁻¹ of DOX.	128
Figure S8. Stability of DOX in different temperatures. All control experiments were carried out without LC, at pH 7 and with 250 µg·L ⁻¹ of DOX.	129
Figure S9. Stability of different DOX concentrations. All control experiments were carried out without LC, at 30 °C and pH 7	129

LIST OF TABLES

CHAPTER 2, 3, 4 and 5

Table 1. Structure and properties of some anticancer compounds and their concentration in wastewater and surface water samples.....	42
Table 2. Studies evaluating the influence of anticancer drugs on bacteria.....	46
Table 3. Studies that use whit-rot fungi to degrade antineoplastic drugs.....	54
Table 4. Composition of the synthetic medium used to select archeaes and feeding the reactors. The medium pH was adjusted to 7.4 using KOH.....	62
Table 5. Specific biogas production rates and inhibition percentages to different concentrations of doxorubicin	67
Table 6. Comparison between the specific initial degradation rates of the laccase (450, 900, and 1800 U·L ⁻¹) to degrade doxorubicin at concentrations of 50, 250, and 500 µg·L ⁻¹ ...	88
Table 7. Comparison of the initial specific degradation rates to degrade doxorubicin at different pH values.....	89
Table 8. Comparison of the initial specific degradation rates to degrade doxorubicin at different temperatures.	91
Table 9. Supporting done to undergraduate and master students during their academic formation.	102

SUPPLEMENTARY MATERIAL

Table S1. Composition of biogas produced by the biomass stabilization reactor.....	125
--	-----

LIST OF ABBREVIATIONS AND SYMBOLS

AD - Anaerobic digestion

AnMBR - Anaerobic membrane bioreactor

COD - Chemical oxygen demand

d - Cell path length.

DOX – Doxorubicin

DOQ – Demanda Química de oxigênio

DOX-DP - Doxorubicin degradation products

EPs - Emerging pollutants

ETEs - Estações de tratamento de efluentes

FO-AnMBR - Osmosis anaerobic membrane bioreactor

HRT - Hydraulic retention time

LC – Laccase

K_M – Michaelis–Menten constant

K_{ow} - Octanol water partition coefficient

NORMAN - Network of Reference Laboratories, Research Centres and Related Organisations for Monitoring of Emerging Environmental Substances

OLR - Organic loading rates

P - Pressure of the gas phase at the time of reading

P₀ - Normal pressure

pK_a - Acid dissociation constant

PPs - Pharmaceutical products

P_w - Vapor pressure of the water as function of the temperature of the ambient space

SBPR - Specific biogas production rate

t - Reaction time

T - Temperature of the fermentation gas of the ambient space

T₀ - Normal temperature

THP - Thermal hydrolysis process

UASB - Upflow Anaerobic Sludge Blanket reactor

$\frac{U}{L}$ - One unit of laccase activity is defined as the amount of enzyme necessary to catalyze 1 μmol of ABTS per min.

v - Volume of the laccase solution.

V - Reactional volume

V_b - Volume of the gas as read off

V_{max} – Maximal degradation rate

V_N - Volume of the gas in the normal state

WWTPs - Wastewater Treatment Plants

Δ_{abs} - Variation of absorbance

ε - Molar extinction coefficient

VSS - volatile suspended solids

v - Initial degradation rate

∂S - Variation of doxorubicin concentration.

∂t - Variation in time

TABLE OF CONTENTS

CHAPTER 1.....	27
1.1 INTRODUCTION	28
1.2 PROBLEM AND MOTIVATION	30
1.3 HYPOTHESES.....	33
1.4 RESEARCH QUESTION	34
1.5 OBJECTIVES.....	35
1.5.1 General objective	35
1.5.2 Specific objectives	35
1.6 CONCEPTUAL DIAGRAM.....	36
CHAPTER 2.....	37
2 LITERATURE REVIEW	38
2.1 EMERGING POLLUTANTS	38
2.2 PRESENCE OF ANTICANCER DRUGS IN THE ENVIRONMENT	39
2.3 THE EFFECT OF ANTINEOPLASTIC DRUGS ON MICROORGANISMS	45
2.4 IMPORTANCE OF METHANOGENESIS TO ANAEROBIC DIGESTION.....	49
2.5 APPLICATION OF ENZYMES TO REMOVE DRUGS	51
2.5.1 Use of white-rot fungi for degradation of antitumor drugs.....	52
2.5.2 Potential application of laccase to remove anti-tumor drugs.....	55
2.6 FINAL CONSIDERATIONS.....	57
CHAPTER 3.....	58
3 INHIBITORY IMPACT OF THE ANTICANCER DRUG DOXORUBICIN ON ANAEROBIC MICROBIAL COMMUNITY	59
3.1 INTRODUCTION	60
3.2 MATERIALS AND METHODS	62
3.2.1 Chemicals.....	62
3.2.2 Inoculum.....	62
3.2.3 Short-term exposure assays	63

3.2.4	Sequential batch assays with and without DOX exposure.....	63
3.2.5	Abiotic test.....	63
3.2.6	Log-term exposure assay.....	64
3.2.7	16S rRNA gene amplification and sequencing.....	64
3.2.8	Analytical methods	65
3.3	RESULTS AND DISCUSSION.....	66
3.3.1	Doxorubicin affect the biogas production in a concentration-dependent way	66
3.3.2	Impact of DOX on biogas production after an abruptly and temporally exposure to the drug.....	68
3.3.3	Sorption of doxorubicin to the biomass	70
3.3.4	Methanogenic long-term exposure to DOX.....	71
3.3.5	The microbial community structure after DOX exposure.....	74
3.4	PARTIAL CONCLUSIONS	76
	CHAPTER 4.....	78
4	LACCASE AS AN EFFICACIOUS APPROACH TO REMOVE ANTICANCER DRUGS: A STUDY OF DOXORUBICIN DEGRADATION, KINETIC PARAMETERS, AND TOXICITY ASSESSMENT	79
4.1	INTRODUCTION	80
4.2	MATERIALS AND METHODS	83
4.2.1	Chemicals.....	83
4.2.2	Laccase activity	83
4.2.2.1	<i>Doxorubicin measurement.....</i>	<i>84</i>
4.2.2.2	<i>Laccase-catalyzed degradation of doxorubicin.....</i>	<i>84</i>
4.2.2.2.1	<i>Effect of laccase concentration on doxorubicin degradation.....</i>	<i>84</i>
4.2.2.2.2	<i>Effect of pH and temperature on doxorubicin degradation</i>	<i>84</i>
4.2.2.2.3	<i>Kinetic parameters of doxorubicin degradation</i>	<i>85</i>
4.2.2.3	<i>Cytotoxicity assay.....</i>	<i>85</i>

4.3	RESULTS AND DISCUSSION.....	86
4.3.1	Degradation of doxorubicin in different laccase concentration	86
4.3.2	Evaluation of optimal pH to doxorubicin degradation	88
4.3.3	Evaluation of different temperatures over doxorubicin degradation.....	90
4.3.4	Determination of Michaelis-Menten kinetic parameters	92
4.3.5	Toxicity of LC degraded metabolites.....	93
4.3.6	Laccase applicability and future trends to remove anticancer drugs from effluents	95
4.4	PARTIAL CONCLUSIONS	96
	CHAPTER 5.....	97
5	FINAL CONTEXTUALIZATION AND OTHER ACTIVITIES.....	98
5.1	FINAL ASPECTS, RELEVANCE AND APPLICABILITY	98
5.1.1	Final aspects and importance of studying the influence of anticancer drugs on the anaerobic digestion microbial community	98
5.1.2	Application of enzymatic processes in the wastewater treatment.....	98
5.2	RESEARCH PROJECT DONE IN THE SANDWICH DOCTORATE.....	100
5.3	ASSESSMENT INDICATORS	102
	CHAPTER 6.....	104
6	CONCLUSIONS AND SUGGESTIONS FOR FUTURE STUDIES.....	105
6.1	CONCLUSIONS	105
6.2	SUGGESTIONS FOR FUTURE STUDIES	106
	REFERENCES	107
	SUPPLEMENTARY MATERIAL	124
	CHAPTER 3 - SUPPLEMENTARY MATERIAL.....	124
	CHAPTER 4 - SUPPLEMENTARY MATERIAL.....	127



Introduction

In this chapter, it is presented a brief introduction to the research developed, the problem and motivation, hypotheses, research question, objectives, and a conceptual diagram.

1.1 INTRODUCTION

In recent years, several studies have shown that the biological process of effluent treatment is not able to remove some pharmaceutical products (PPs) completely (COETSIER *et al.*, 2009; TERNES *et al.*, 1998; VERLICCHI *et al.*, 2012). These drugs, as well as their metabolites, have been detected in surface water at concentrations that can range from nanograms to micrograms per liter (COETSIER *et al.*, 2009; NEGREIRA; DE ALDA; BARCELÓ, 2014). Furthermore, the continuous release of these substances, their metabolites and possible additive or synergistic effects represent a potential risk to the environment (ZHANG *et al.*, 2013).

Among the PPs, anticancer drugs have been focused on their high toxicity, added to the difficulty of being removed through conventional wastewater treatment plants (WWTPs) (FRANQUET-GRIELL *et al.*, 2017; OLALLA *et al.*, 2018). Pharmaceutical industries, hospitals and homes (patients receiving treatment without being hospitalized) are the sources of anticancer drugs in effluents (BOOKER *et al.*, 2014; KOSJEK; HEATH, 2011). It is assumed that hospitals are the main source of these drugs, and their effluents are rarely subjected to any treatment before being released into the municipal sewage system (ZHANG *et al.*, 2013). Several studies have already reported the presence of anticancer drugs in surface water and hospital or urban effluents (BUERGE *et al.*, 2006; ISIDORI *et al.*, 2016; LENZ *et al.*, 2005; MAHNIK *et al.*, 2007; VYAS; TURNER; SEWELL, 2014).

The action mechanisms of these drugs in microorganisms are unknown or unclear. However, they act directly on the DNA generating concern about the potential to inhibit the activity of biological communities from WWTPs (ZHANG *et al.*, 2013, SANTANA-VIERA *et al.*, 2016). Franquet-griell *et al.* (2017) have reported that 50 $\mu\text{g}\cdot\text{L}^{-1}$ of cytarabine negatively affects the bacteria activity from waste activated sludge after 5 operation cycles. Adding azathioprine, cyclophosphamide, doxorubicin, epirubicin, flutamide, methotrexate, mitotane and tamoxifen into an osmosis anaerobic membrane bioreactors increased the production of extracellular polymeric substances, which is associated with stress conditions (WU *et al.*, 2017). It is well known that patients in chemotherapy have alterations in intestinal microbiota (FLÓREZ *et al.*, 2016). According to the bacteria or the anticancer drug studied, relative abundance alteration or a dose-dependent inhibition is reported as side effects. (FLÓREZ *et al.*,

2016; TANG *et al.*, 2017). However, there are few studies reporting the influence of these drugs on microorganisms.

The removal of organic matter can be carried out by aerobic or anaerobic processes (e.g., anaerobic digestion). Anaerobic digestion (AD) processes occur in four main steps: hydrolysis, acidogenesis, acetogenesis and methanogenesis (CREMONEZ *et al.*, 2021). The methanogenesis is carried out by a group of microorganisms belonging to the archaea domain (FERRY, 1993). Methane production occurs via acetoclastic methanogenesis and hydrogenotrophic methanogenesis (CREMONEZ *et al.*, 2021; YANG; ZHANG; HU, 2013). In the first one, acetate is converted to methane by *Methanosarcina* and *Methanosaeta* genus. Meanwhile, hydrogenotrophic methanogenesis occurs by converting CO₂ and H₂ to methane by the *Methanobacterium*, *Methanobrevibacter* and *Methanospirillum* (YANG *et al.*, 2014). Methanogenesis can be considered the limiting step in AD (STEINMETZ, 2016). The methanogens present a high susceptibility to environmental stresses conditions as changes pH, temperature, salinity and the concentration of potential inhibitory compounds (e.g., ammonia, pharmaceuticals, volatile fatty acids, phenolic compounds) (FÁBEROVÁ *et al.*, 2019; GHASIMI *et al.*, 2016; LEE; KIM; HWANG, 2021; ZHANG *et al.*, 2018). Thus, it is crucial to elucidate the influence of inhibitory compounds over archaea. So far in our acquaintance, it was not reported the influence of anticancer drugs on methanogenesis. The Environmental Biotechnology Laboratory (e-biotech/UFSC) has been developing several studies to evaluate the effect of emerging pollutants (EPs) on microorganisms from WWTPs. Bressan (2012) evaluated the influence of colistin (antibiotic from pig farm) in an enriched ammonia-oxidizing bacteria culture and an enriched acetoclastic methanogenesis archaeas. Perazzoli (2015) evaluated the effect of iron oxide nanoparticles on an enriched culture of ammonia-oxidizing bacteria. Michels (2016) evaluated the effect of silver nanoparticles on an enriched culture of ammonia-oxidizing bacteria. Steinmetz (2016) evaluated the inhibition of antibiotics and growth promoters used in pig farms on biogas production. Lastly, Langbehn (2018) evaluated the effect of tetracycline and oxytetracycline on a mixed culture of enriched ammonia-oxidizing bacteria.

Anticancer drugs present high recalcitrance, also showing an inhibitory potential for microbial communities from WWTPs. Therefore, it is necessary to apply alternative strategies for removing anticancer drugs. Recent studies demonstrate the effectiveness of white rot fungi in removing some anticancer drugs (FERRANDO-CLIMENT *et al.*, 2015). This removal is attributed to the action of extracellular enzymes, especially laccase (CASTELLET-ROVIRA *et*

al., 2018). However, the direct application of free enzymes originating from white rot fungi to remove anticancer drugs is still an innovation. Furthermore, due to its non-specificity for the substrate, laccase has great potential for their degradation. To the best of our knowledge, our research group (Environmental Biotechnology Laboratory - e-biotech/UFSC) were the first to indicate the potential of the free laccase to degrade anticancer drugs. We recently published a review paper entitled “Potential of enzymatic process as an innovative technology to remove anticancer drugs in wastewater” (PEREIRA *et al.*, 2020). After, another research group published a review paper indicating the potential of enzymes for this application (YADAV *et al.*, 2020). A master thesis from e-biotech was presented by Pereira (2020), where she applied free laccase to degrade the anticancer drug etoposide. Lastly, Zdarta *et al.* (2022) have reported in their review paper that a novel research direction on the application of enzymes for the removal of anticancer drugs was established by our research group, referencing the research paper which compose this thesis (KELBERT *et al.*, 2021)

1.2 PROBLEM AND MOTIVATION

Water is essential for life, being needed for human hydration and food preparation, personal hygiene, industrial processes, etc. However, ingestion of water without proper treatment raises concern as it may cause health harm due to the presence of pathogenic microorganisms and chemical compounds (WORLD HEALTH ORGANIZATION, 2017). In addition, the lack of potable water and sanitation distribution leads to additional public health spending, reaching millions of dollars a year (HALLER; HUTTON; BARTRAM, 2007). Therefore, the distribution of drinking water and the proper treatment of effluent from homes, industries, and hospitals is necessary (WORLD HEALTH ORGANIZATION, 2017).

Among the PPs, we can mention the anticancer drugs. In recent years, these drugs have been raising attention due to high toxicity levels and increased consumption (caused by the increase in cancer incidence). The main source of anticancer drugs for the environment are hospitals (where chemotherapy is carried out) and houses (patients receiving treatment at home) (BESSE; LATOUR; GARRIC, 2012; BOOKER *et al.*, 2014; KOSJEK; HEATH, 2011). No regulation in Brazil requires a specific treatment of effluent from hospitals. Instead, they are directed to the municipal WWTPs, receiving the same treatment as domestic sewage. The pharmaceutical industry is also responsible for the emission of chemotherapy drugs. However, in some cases, companies already have an advanced system to reduce the emission of these

pollutants. Nonetheless, resolution 430/2011 CONAMA (CONAMA, 2011) does not mention release standards for anticancer drugs, with no control over emissions.

The drugs role in the WWTPs depend on their sorption capacity. The sorption can happen by adsorption or absorption (BESHA *et al.*, 2017). The adsorption occurs by the electrostatic attraction of the substance to other surfaces. For that, the drug needs to be ionizable in the aqueous phase. The acid dissociation constant (pK_a) rules the electrostatic interaction. For example, when the drug presents positively charged groups, electrostatic interaction occurs to the negatively charged surface of the microorganism (MAI; STUCKEY; OH, 2018). Meanwhile, the absorption is a result of hydrophobic interactions. The value of the octanol-water partition coefficient (K_{ow}) rules the absorption. For example, hydrophobic interactions between aliphatic or aromatic groups presented in the drug with the lipid fractions of the sludge or the lipophilic cell membrane (ZHANG *et al.*, 2013).

Figure 1 represents the simplified scheme of a conventional WWTP. The blue arrows represent the water flow, and the brown arrows represent the sludge flow. As discussed above, according to the characteristics of the substances, they will be sorbed in the solid phase or will stay in the liquid phase.

Figure 1. Simplify the scheme of a conventional wastewater treatment plant. The blue arrow is the water flow, and the brown arrow represents the solid flow.

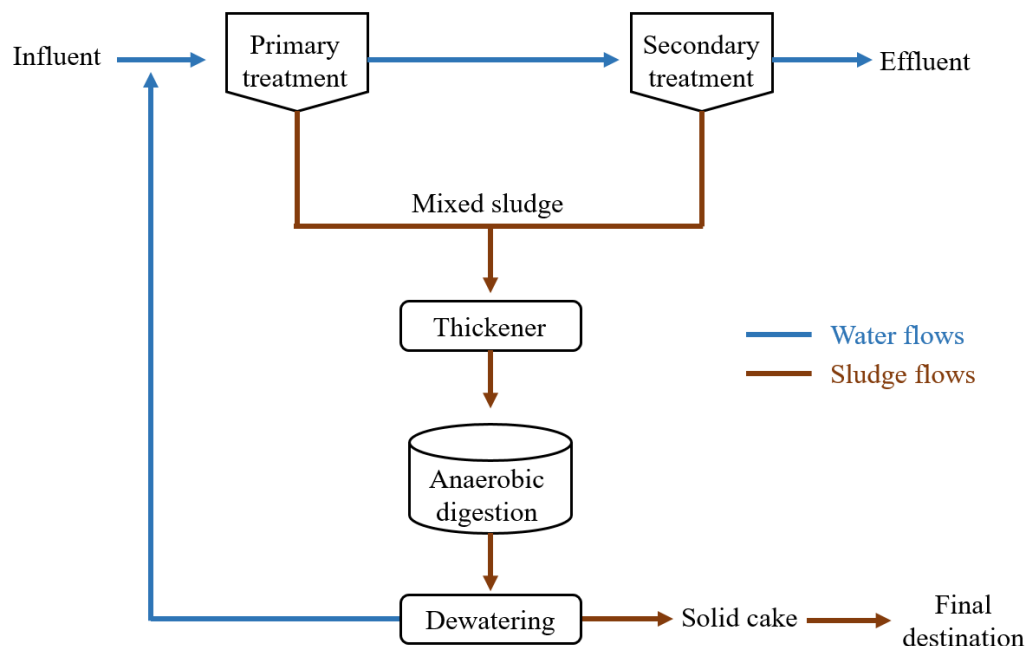

Source: From the author.

Several anticancer drugs show recalcitrance to conventional wastewater treatment (NEGREIRA; DE ALDA; BARCELÓ, 2014). Anticancer drugs, which are sorbed into the sludge, go to an anaerobic reactor. Once they show the potential to inhibit a microbial community, they can also interfere in AD. The methanogenesis, as a limited step, may be affected by the presence of these drugs. Anaerobic processes on their own are also an interesting alternative to application to decentralized treatment (CREMONEZ *et al.*, 2021). Reactor configuration as an anaerobic membrane bioreactor (anMBR) and upflow anaerobic sludge blanket reactor (UASB) can be used in the treatment of effluents from hospitals (MUÑOZ SIERRA *et al.*, 2019; ZHANG *et al.*, 2019). The inhibit growth or in the metabolism can compromise the entire sewage treatment. The methanogens are sensible to several compounds and environmental conditions (LEE; KIM; HWANG, 2021). Furthermore, they have a slow-growing rate, raising concern about their inhibition (ROOPNARAIN *et al.*, 2021).

If these drugs pass through the WWTPs, they can cause damage to the environment (QUEIRÓS *et al.*, 2021). Ecotoxicity studies demonstrate that even at low concentrations, these drugs present a risk to the environment. For example, eco-genotoxicity assays showed that doxorubicin, cisplatin, etoposide, and imatinib cause DNA damage in cells of *Ceriodaphnia dubia* and *Daphina magna* in the range of concentration of $\mu\text{g}\cdot\text{L}^{-1}$ (LAVORGNA *et al.*, 2015). Another study also demonstrates that cyclophosphamide and 5-fluorouracil (at environmental concentrations) can cause intestines changes and influence the interocular distance in tadpoles (*Lithobates catesbeianus*) (ARAÚJO *et al.*, 2019). In addition, as shown in Figure 2 A, it can also trigger malignant cell transformation processes (cancer) after 30 days of exposure.

Figure 2. Ecotoxicological impact of anticancer on aquatic animal. A) Gut of a tadpoles exposure to cyclophosphamide and 5-fluorouracil (red arrow indicate the malignant cell transformation processes). B) Zebrafish embryos exposure to vincristine, red arrows indicate the pericardial area; E indicate eye; PC is pericardial cavity; S is spine; T, is tail; TT is tail tip; YS is yolk sac.

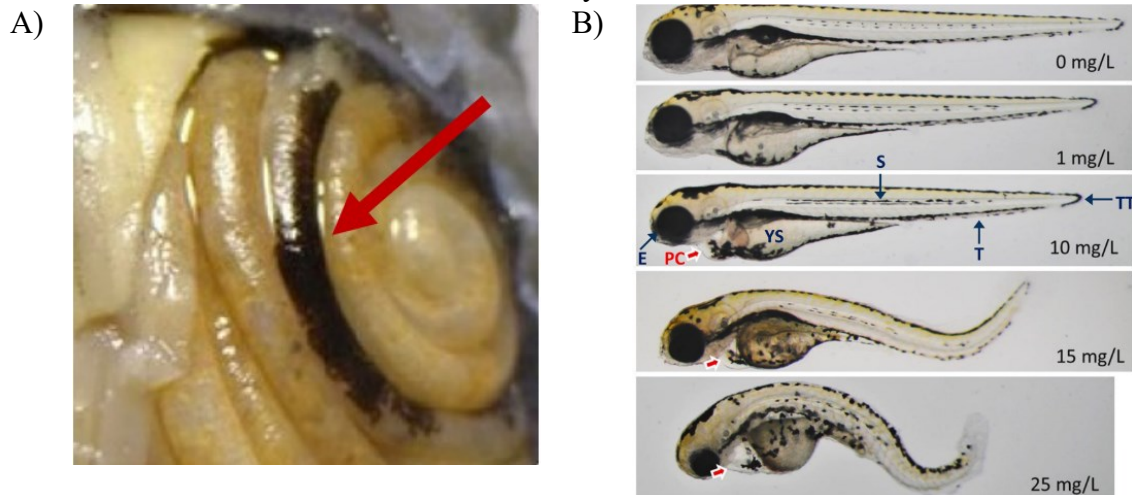

Source: A) From Araújo *et al.*, (2019) and B) From Hung *et al.*, (2021).

The acute exposure of the anticancer drug vincristine on zebrafish embryonic development showed a significant teratogenic effect (HUNG *et al.*, 2021). Figure 2 B shows the authors' results, which include growth retardation, pericardial edema, spine, tail, and yolk sac malformations, decreased heart rate, and ocular malformations. Furthermore, the study also reports significant damage to the microridge-structure of skin keratinocytes.

1.3 HYPOTHESES

The thesis has two main hypotheses; each is related to the experimental chapter.

- **Hypothesis to chapter 3:** The anticancer drugs can affect the microbial community from a WWTP, in special archaeas, which are crucial microorganisms to anaerobic digestion.
- **Hypothesis to chapter 4:** The laccase can be applied to degrade anticancer drugs in environmental conditions, and the degradation products show less toxicity than the original compound.

1.4 RESEARCH QUESTION

Figure 3. The research questions of the thesis.

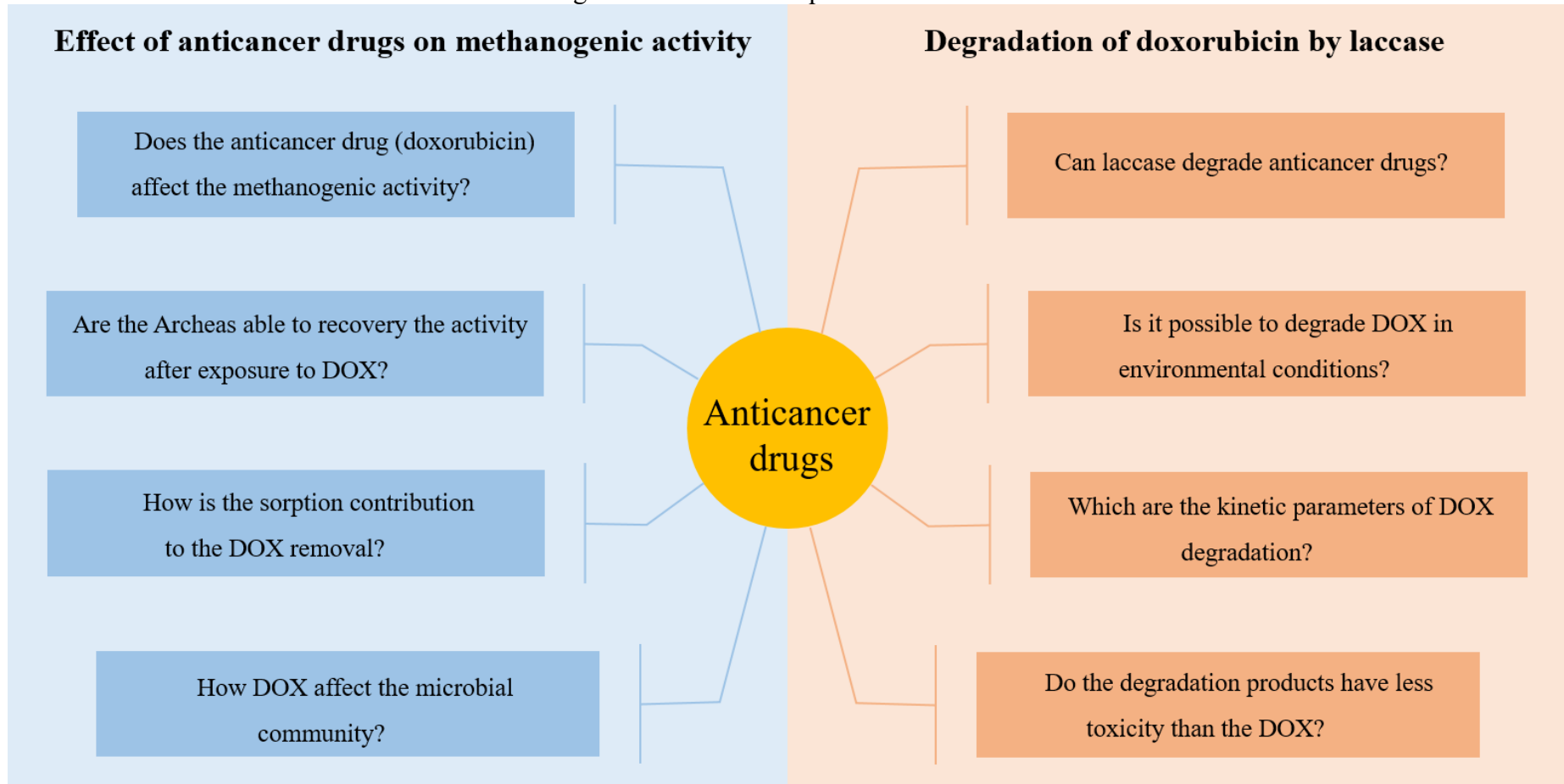

Source: From the author

1.5 OBJECTIVES

1.5.1 General objective

The thesis proposes to evaluate the effect of the anticancer drug doxorubicin (DOX) on anaerobic digestion using an enriched archaeas culture from an effluent treatment plant and propose an alternative method for removing anticancer drugs using free enzymes.

1.5.2 Specific objectives

The specific objectives selected to fulfill the main objective are:

Specific objectives to chapter 3:

- Determine the effect of DOX concentrations on the microbial activity of an enriched culture of methanogenic archaeas in short-term assays.
- Verify the DOX sorption into the anaerobic biomass.
- Evaluate the influence of DOX on long-term exposure to the enriched culture of methanogenic archaeas.
- Determine the population and relative abundance of microbial community after long-term exposure to DOX;

Specific objectives to chapter 4

- Evaluate the potential of a commercial laccase from *Trametes versicolor* to degrade doxorubicin.
- Determine the optimal pH and temperature as well as the kinetic constants of the enzymatic degradation of doxorubicin.
- Evaluate the toxicity of the degradation products of doxorubicin by laccase.

1.6 CONCEPTUAL DIAGRAM

Figure 4. Conceptual diagram of the thesis showing the problem and motivation, thesis structure, what was evaluated in each experimental chapter, and deliverables.

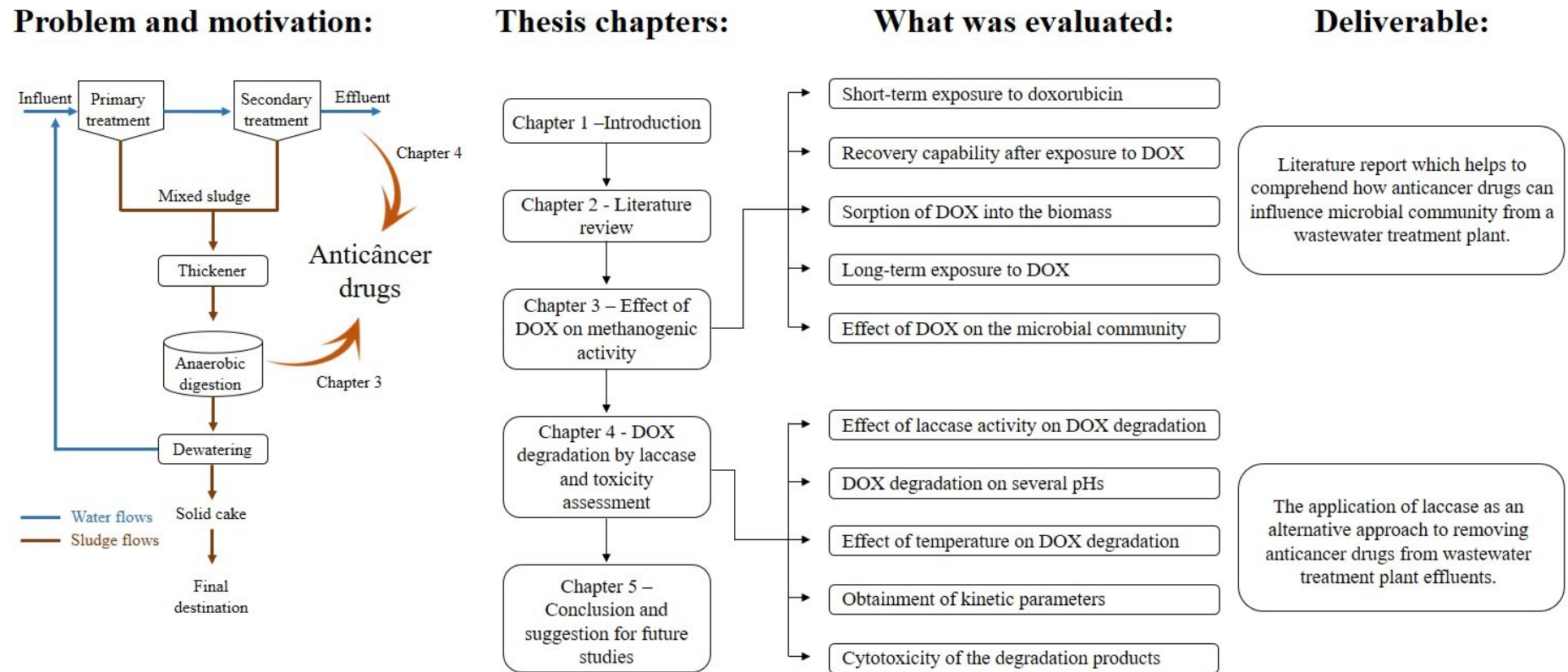

Source: From the author

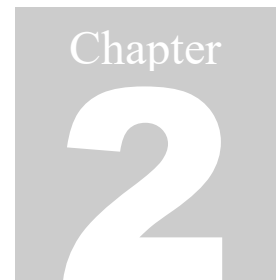
A square graphic with a grey background. The word "Chapter" is written in a white serif font at the top. Below it, the number "2" is written in a large, white, stylized serif font.

Literature review

This chapter presented a literature review of researches about emerging pollutants, anticancer drugs (potential risk and effect on bacteria), the importance of methanogenesis to anaerobic digestion. It also contemplates the uses of fungi to degrade anticancer drugs, mainly by laccase, which has the potential to be used on the degradation of these compounds.

2 LITERATURE REVIEW

2.1 EMERGING POLLUTANTS

EPs are substances that have the potential to be added to future legislation. They are not included in the monitoring routines of effluent treatment plants (WWTPs). Nonetheless, show risk to the environment and human health (NORMAN, 2016). These contaminants can be originated from several sources, such as hospitals, houses, and industries. Among EPs, we can include personal care products, chemicals, pesticides, pharmaceuticals used in human and animal health, surfactants, hormones, etc. (LUO *et al.*, 2014; WILKINSON *et al.*, 2017). In 2016, the NORMAN (Network of Reference Laboratories, Research Centres and Related Organisations for Monitoring of Emerging Environmental Substances) published a list containing more than one thousand EPs compounds.

WWTPs are not designed to remove EPs efficiently. Thus, they can be detected (e.g., in wastewater, surface water and groundwater) in concentrations ranging from $\text{ng}\cdot\text{L}^{-1}$ to $\mu\text{g}\cdot\text{L}^{-1}$ (GOGOI *et al.*, 2018; TAHERAN *et al.*, 2018). Their occurrence are becoming a new challenge in the operation of WWTPs, which are focused on removing easily or moderately biodegradable carbon, nitrogen, and phosphorus (DEBLONDE; COSSU-LEGUILLE; HARTEMANN, 2011; VERLICCHI; AL AUKIDY; ZAMBELLO, 2012). Furthermore, it is still unclear how several EPs can affect the efficiency of the effluent treatment process (LI, 2014). Some EPs can inhibit the microbial activity from several microorganisms, including those present in WWTPs, generating an impact on nutrient removal (LUO *et al.*, 2020).

The pesticide Tara-909 (at a concentration of $5 \mu\text{g}\cdot\text{mL}^{-1}$) inhibited the methanogenic activity on anaerobic sewage sludge (CHAKRABORTY; SARKAR; LAHIRI, 2002). While, the antibiotic tetracycline has caused the total collapse in an anaerobic sequential batch reactor (ASBR), being lethal to the microbial community at a concentration of $8.5 \text{mg}\cdot\text{L}^{-1}$ (CETECIOGLU *et al.*, 2013). Silver nanoparticles, known for their antimicrobial properties, can interfere with nitrification while stimulating N_2O production. (MICHELS *et al.*, 2015). Another problem related to the continuous exposure of bacteria to EPs is antimicrobial resistance which raises a global concern in multiple sectors, especially agriculture, human and animal health (VIANA *et al.*, 2018). WWTPs constantly receive compounds with antimicrobial activity (SZEKERES *et al.*, 2017). Thus, the continuous release of EPs can stimulate the emergence of antimicrobial resistance genes and, consequently, the rise of superbugs (VIANA *et al.*, 2018). In addition to causing harmful effects on the microbial community, as mentioned

above, in recent years, several studies have shown that biological treatments of effluents (at the secondary and tertiary level) are not able to remove completely some EPs (especially pharmaceutical products) (COETSIER *et al.*, 2009; TERNES *et al.*, 1998).

The continuous emission of drugs and degradation products added to possible additive or synergistic effects represents a risk to the environment (ZHANG *et al.*, 2013). Once released, they can reach rivers, lakes and groundwater, normally used for water collection to potability or recreation activities (BAI *et al.*, 2018; VERLICCHI; AL AUKIDY; ZAMBELLO, 2012). So far, the incidence of EPs in drinking water may not represent a significant risk to human health as pathogens (e.g., *Legionella*). However, the increase in environmental concentration raises public concern (WORLD HEALTH ORGANIZATION, 2018).

The insertion of the EPs into the legislation is a trend that is already glimpsed. In 2018, the European Commission established the Commission Implementing Decision (EU) 2018/840. As a result, a list of substances to be monitored in surface water was implemented, including some EPs (e.g., anti-inflammatory drugs, antibiotics and hormones). However, in Brazil, no regulation requires specific treatment to EPs. Furthermore, there is no inspection regarding the presence or release of these compounds in wastewater or surface water since CONAMA resolution 430/2011 does not mention them in release standards. However, the ORDINANCE GM/MS N° 888 from MAY 4 of 2021, has recently published a regulation establishing limits of the presence of 54 agronomics or their degradation products in drinking water (DIÁRIO OFICIAL DA UNIÃO, 2021). The maximum permitted value is still high, with the maximum concentration ranging from 0,03 to 180 $\mu\cdot\text{L}^{-1}$, but is a starting to further regulations.

Among the EPs, several drugs show a higher environmental risk, as anticancer drugs. They are already included in the list of emerging pollutants presented by the NORMAN (2016). However, like most EPs, no environmental legislation contemplates them, and due to their high level of toxicity, the environmental risk that anticancer drugs can cause is increasingly discussed (ČESEN *et al.*, 2015).

2.2 PRESENCE OF ANTICANCER DRUGS IN THE ENVIRONMENT

In 2012, about 14.1 million new cancer cases were diagnosed worldwide (TORRE *et al.*, 2015). It is estimated that in 2030 this number will exceed 20 million (BRAY *et al.*, 2012), and by 2040 this number will reach 29.5 million (INTERNATIONAL AGENCY FOR

RESEARCH ON CANCER, 2018). Figure 5 presents the perspectives of the numbers of new cancer cases in the world.

Figure 5. Perspectives of cancer incidence

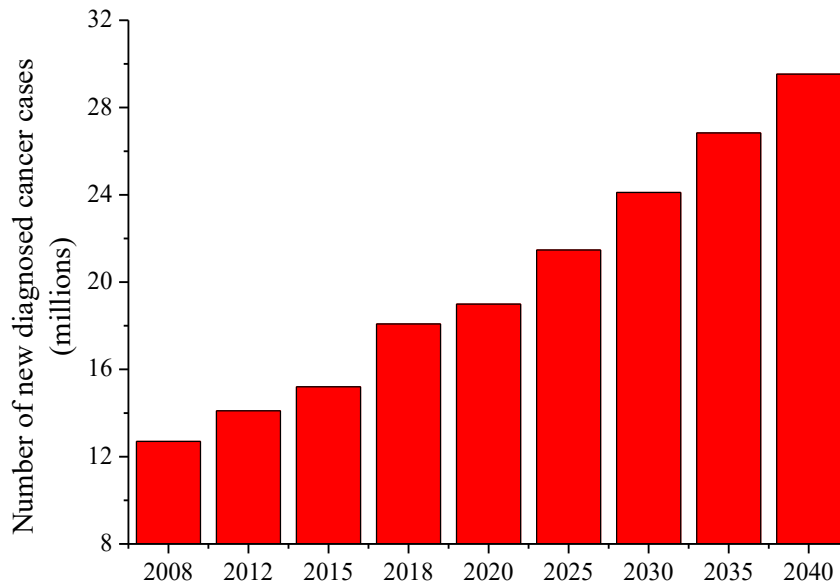

Source: Adapted from Brayet al (2012), IARC (2018) and Torres et al (2015)

The prospects for new cancer cases already present exorbitant data. When it comes to the number of people living with the disease and receiving treatment, this number is even higher. In 2017 there were more than 100 million people with cancer in the world (ROSER; RITCHIE, 2018). Anticancer drugs are administered for a long period to achieve the maximum therapeutic effect. They are rapidly metabolized and eliminated from the body after administration (ZAIDI, 2019). Depending on the type of tumor and treatment, the administration of these drugs can last for years. Tamoxifen, for example, is given to patients for 5 years after the end of chemotherapy to prevent recurrence (CRISCITIELLO *et al.*, 2011; EARLY BREAST CANCER TRIALISTS' COLLABORATIVE GROUP, 2005).

Once administered, anticancer drugs are either metabolized by our body or remain unchanged (BOOKER *et al.*, 2014). They are excreted through urine or feces (FRANQUET-GRIELL *et al.*, 2015). The excretion rate can vary from values of 1% (estramustine) to close to 100% (busulfan). Anticancer drugs have been discharged directly into the sewage system without specific control (ZHANG *et al.*, 2013).

The emission sources of these pollutants can be homes, pharmaceutical industries or hospitals (Figure 6). However, it is important to emphasize that the biggest emitters of anticancer drugs are hospitals (in their sanitary sewer) and the pharmaceutical industries where

they are produced (BESSE; LATOUR; GARRIC, 2012; BOOKER *et al.*, 2014; KOSJEK; HEATH, 2011).

Figure 6. Emission sources of anticancer drugs

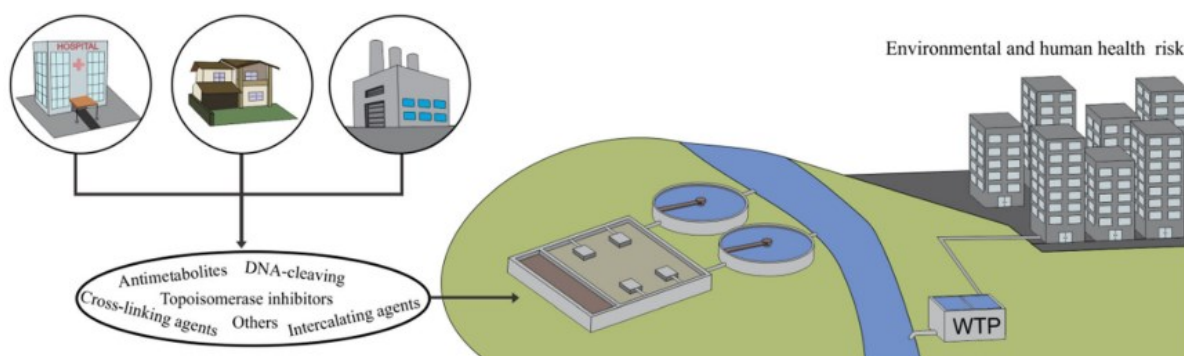

Source: Pereira *et al.*, 2020

Anticancer drugs are recalcitrant substances in conventional biological wastewater treatment (FRANQUET-GRIELL *et al.*, 2017; OLALLA *et al.*, 2018). Once in the environment, there is little information about their short and long-term effects. However, it is known that these compounds can be carcinogenic, mutagenic, toxic, teratogenic etc. (ČESEN *et al.*, 2015; NEGREIRA; LÓPEZ DE ALDA; BARCELÓ, 2013). In addition, they may cause serious damage to the ecosystem, even at low concentrations (ZAIDI, 2019). Meanwhile, the biotic and abiotic processes (both in an effluent treatment plant and in the environment) can result in new chemical compounds called transformation products, showing new biological properties (ZHANG *et al.*, 2013).

They have been detected in surface water at concentrations ranging from nanograms to micrograms per liter (NEGREIRA; DE ALDA; BARCELÓ, 2014). Several anticancer drugs were detected on surface water or hospital and urban effluents in countries such as Austria (LENZ *et al.*, 2005), China (YIN *et al.*, 2010), Slovenia (ISIDORI *et al.*, 2016), Spain (NEGREIRA; DE ALDA; BARCELÓ, 2014) and England (VYAS; TURNER; SEWELL, 2014). In addition, some drugs such as etoposide, ifosfamide, cyclophosphamide, doxorubicin, tamoxifen are not removed after conventional biological treatment and can be released unaltered into surface water (BOOKER *et al.*, 2014; LÓPEZ-SERNA *et al.*, 2013). Table 1 shows some anticancer drugs, their proprieties, and the concentration found in wastewater and surface water.

Table 1. Structure and properties of some anticancer compounds and their concentration in wastewater and surface water samples

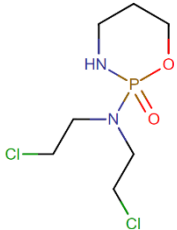
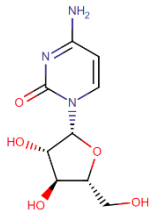
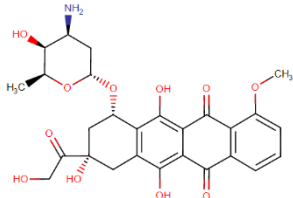
Substance	Molecule ^a	Log Kow ^b	pKa	Water Solubility at 25 °C (mg/L) ^a	Wastewater concentration range (ng·L ⁻¹)	Surface water concentration range (ng·L ⁻¹)
Cyclophosphamide		0.97	2.84 ^d	1.51×10 ⁴	2 -22100 ^{c,f, g,h}	6.3 – 100 ^{c,h}
Cytarabine		-2.46	8.74 ^a	4.38×10 ⁴	n.a	n.a
Doxorubicin		1.27	8.2 ^e	1.18×10 ³	2.6 –13500 ^h	20 – 42 ^{h, i}

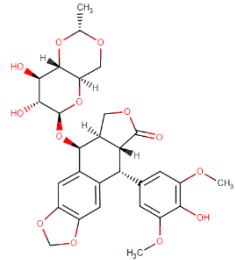
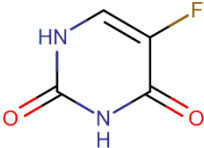
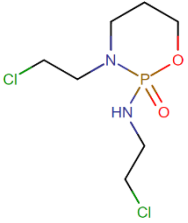
Etoposide	 <p>The structure shows a complex molecule with a central chromane ring system. It features a methyl group (CH₃) at the top, a hydroxyl group (HO) on the left, and a methyl ether group (H₃C-O) at the bottom. The structure is highly substituted with various functional groups and stereocenters.</p>	0.04	9.33 ^c	9.78×10^2	5 – 5141 ^{c, f}	n.a
5-Fluorouracil	 <p>The structure is a pyrimidine ring with a fluorine atom (F) at the 5-position, a carbonyl group (C=O) at the 2-position, and a carbonyl group (C=O) at the 4-position. The nitrogen atoms are labeled with H and NH.</p>	− 0.81	8.02 ^a	5.86×10^3	5 – 124000 ^g	n.a
Ifosfamide	 <p>The structure shows a central phosphorus atom (P) double-bonded to an oxygen atom (O) and single-bonded to a nitrogen atom (N). The nitrogen atom is bonded to a chlorine atom (Cl) and a propyl chain. The phosphorus atom is also bonded to a nitrogen atom (N) which is part of a six-membered ring containing an oxygen atom (O) and a chlorine atom (Cl).</p>	0,97	1.44 ^d	1.50×10^4	2 – 10647 ^{f, g}	151 ^{f, g}

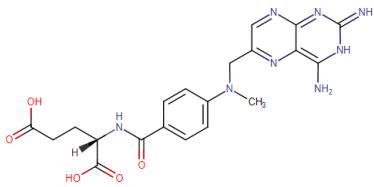
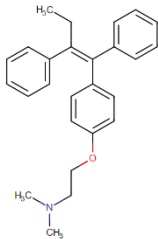
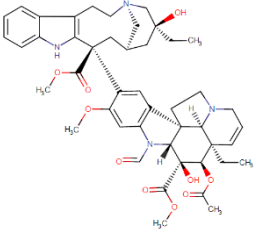
Methotrexate		-1.28	4.7 ^a	8.19×10^1	4 – 4689 ^{f, g, h}	17 – 60 ^c
Tamoxifen		6.31	8.76 ^c	1.02	143 -740 ^{g, h}	180 ^h
Vincristine		3.11	10.85 ^c	0.12	1851 ^c	n.a

Source: ^a DRUGBANK (<https://go.drugbank.com/>); ^b Li *et al.* (2021); ^c Santana-Viera *et al.* (2019); ^d Negreira *et al.* (2013); ^e Wang *et al.* (2018); ^f Yin *et al.* (2010); ^g Isidori *et al.* (2016); ^h Negreira; de Alda; Barceló, (2014), ⁱ Martín *et al.* (2014); n.a.: not available or incomplete data.

If anticancer drugs contaminate water and soil, they can cause harmful effects to humans and wildlife (ZAIDI, 2019). For example, eco-genotoxicity studies showed that doxorubicin causes DNA damage in *Ceriodaphnia dubia* cells in concentration $0.05 \mu\text{g}\cdot\text{L}^{-1}$ (LAVORGNA *et al.*, 2015). Negreira *et al.* (2015) evaluated the ecotoxicity of tamoxifen and its metabolites after treatment by chlorination (used as a disinfectant agent in water potabilization processes). They demonstrated that this process rapidly degrades tamoxifen metabolites, and the transformation products show ecotoxicity up to 110 times greater in *Daphnia magna* and *Pimephales promelas*.

2.3 THE EFFECT OF ANTINEOPLASTIC DRUGS ON MICROORGANISMS

Some of the anticancer drugs present can be bioaccumulated, adsorbed on solids or even interfere with the activity of the microbial community (SANTANA-VIERA *et al.*, 2016). These drugs are complex molecules and have the most varied mechanisms of action in multicellular organisms (such as DNA intercalants, antimetabolites, crosslinking agents, among others) (NUSSBAUMER *et al.*, 2011). However, its mechanisms of action in microorganisms are unclear or unknown, presenting potential harmful effects to them (ZHANG *et al.*, 2013).

A wide range of these drugs comes from microbial metabolites as anthracyclines, bleomycin, dactinomycin and mithramycin (DEMAIN; SANCHEZ, 2009). They are considered antibiotics with antitumoral activities (GRENNI; ANCONA; BARRA CARACCILO, 2018). Thus they can inhibit the microbial activity, highlighting those present in effluent treatment plants.

To the best of our knowledge, there are few studies reporting the effect of these drugs on microorganisms. Table 2 shows studies that show the exposure effect of microorganisms to anticancer drugs.

Table 2. Studies evaluating the influence of anticancer drugs on bacteria

Anticancer drug	Concentration	Microorganism	Effect	Reference
Doxorubicin	330 μM	<i>E. coli</i> wild strain	Only 34% of the bacteria have survived after 30 min of exposure.	Anderson <i>et al.</i> (1993)
	1 - $>128 \text{ mg}\cdot\text{L}^{-1}$	Bacteria from the intestinal mucosa	28 of the 34 bacteria tested had IC_{50} at concentrations below $128 \text{ mg}\cdot\text{L}^{-1}$	Flórez <i>et al.</i> (2016)
Cyclophosphamide	$>128 \text{ mg}\cdot\text{L}^{-1}$	Bacteria from the intestinal mucosa	It was not possible to determine the IC_{50} at the concentrations tested	Flórez <i>et al.</i> (2016)
	$>1,000 \text{ mg}\cdot\text{L}^{-1}$	<i>Pseudomonas putida</i>	It was not possible to determine the IC_{50} at the concentrations tested	Zounková <i>et al.</i> (2007)
Cyclophosphamide and its metabolites	From 18 to $176 \mu\text{g}\cdot\text{L}^{-1}$	Aerobic membrane reactor	Increased endogenous respiration rates and decreased exogenous respiration rates, suggesting stress conditions caused by the drug.	Delgado <i>et al.</i> (2010)
Cisplatin	$1.2 \text{ mg}\cdot\text{L}^{-1}$	<i>Pseudomonas putida</i>	IC_{50} value of the drug on the bacteria	Zounková <i>et al.</i> (2007)
Cytarabine	$50 \mu\text{g}\cdot\text{L}^{-1}$	Waste activated sludges	After 5 cycles, there was a decrease in reactor performance, attributed to lower bacterial activity.	Franquet-Griell <i>et al.</i> (2017)
Etoposide	$630 \text{ mg}\cdot\text{L}^{-1}$	<i>Pseudomonas putida</i>	IC_{50} value of the drug on the bacteria	Zounková <i>et al.</i> (2007)
5-Fluorouracil	From 0.25 to $128 \mu\text{g}\cdot\text{L}^{-1}$	Bacteria from the intestinal mucosa	28 of the 34 bacteria tested had IC_{50} at concentrations below $128 \text{ mg}\cdot\text{L}^{-1}$	Flórez <i>et al.</i> (2016)

	30 mg·kg ⁻¹	Microbial population of rats gut	The drug caused a drastic shift in the gut microbiota. Both the total abundance of bacteria and the population of individual microbial groups	Tang <i>et al.</i> (2017)
	27 µg·L ⁻¹	<i>Pseudomonas putida</i>	IC ₅₀ value of the drug on the bacteria	Zounková <i>et al.</i> (2007)
Methotrexate	15 mg·L ⁻¹	<i>Vibrio fischer</i>	Inhibition of 100%	Bialk-Bielinska <i>et al.</i> (2017)
A mix of 8 drugs (azathioprine, cyclophosphamide, doxorubicin, epirubicin, flutamide, methotrexate, mitotane and tamoxifen)	100 µg·L ⁻¹ of each drug	Microorganisms from an osmosis anaerobic membrane bioreactors	The presence of the drugs caused the inhibition of microbial metabolism and increased the extracellular polymer concentration.	Wu <i>et al.</i> (2017)

Some authors as Flórez et al (2016) e Tang et al (2017) study the effect of these drugs on bacteria from the intestinal mucosa. These studies are intended to improve the well-being of patients who receive chemotherapy treatment. Furthermore, we can observe that anticancer drugs act differently in different strains. For example, 5-Fluorouracil and doxorubicin have shown values of IC_{50} at low concentrations compared to drugs such as cyclophosphamide (to microorganisms from the gut).

Franquet-Griell et al. (2017) have reported that $50 \mu\text{g}\cdot\text{L}^{-1}$ of cytarabine negatively affected the activated sludge activity after operational cycles. According to Delgado *et al.* (2010), the exposure of microorganisms in membrane reactor (for 223 days) to cyclophosphamide and its main metabolites generated stressful conditions for them, which increased endogenous respiration rates and a decrease in exogenous respiration rate.

Anaerobic microorganisms from an osmotic anaerobic membrane bioreactor (FO-AnMBR) were exposed to a mix of 8 drugs (azathioprine, cyclophosphamide, doxorubicin, epirubicin, flutamide, methotrexate, mitotane and tamoxifen) (WU *et al.*, 2017). The concentration of $100 \mu\text{g}\cdot\text{L}^{-1}$ for each drug caused an increase in the concentration of extracellular polymeric substances and decreased the rate of methane production.

Few studies show the effect of anticancer drugs on microorganisms from WWTPs. However, it is possible to understand the potentially harmful effects these pollutants can cause to microbial communities, especially with the expectation of increasing their concentration in effluents. WWTPs have a complex microbial community, and changes in the structure of these communities are an important parameter to be evaluated (PONCE-ROBLES *et al.*, 2018). Due to the microbial complexity, the inhibition of a single group of microorganisms may cause an imbalance in the entire community. Consequently, the nutrient removal might have the performance impaired.

In anaerobic processes, several groups of microorganisms are involved, from the initial degradation of organic matter to the formation of biogas. The last step in this process is the methanogenesis, performed by microorganisms belonging to the domain Archaea (FERRY, 1993). The methanogenesis can be considered a limiting step in this process, and if any compound or environmental condition inhibits the methanogenic activity, the organic matter removal may be affected (STEINMETZ, 2016).

2.4 IMPORTANCE OF METHANOGENESIS TO ANAEROBIC DIGESTION

The removal of organic matter through wastewater treatment processes operating in anaerobic conditions (called AD) is used worldwide to treat effluents, such as wastewater, sludge and organic fractions of solid waste (FOUNTOULAKIS; STAMATELATOU; LYBERATOS, 2008). These processes are complex and involve a consortium of microorganisms living in syntrophism. Each group of microorganisms can be classified according to the metabolic pathways they rule: hydrolysis, acidogenesis, acetogenesis and methanogenesis (AYDIN *et al.*, 2015; GHATTAS *et al.*, 2017; TOWN *et al.*, 2014). Figure 7 shows the scheme of degradation of organic matter through AD.

Figure 7. Representative scheme of anaerobic digestion steps: hydrolysis, acidogenesis, acetogenesis, and methanogenesis.

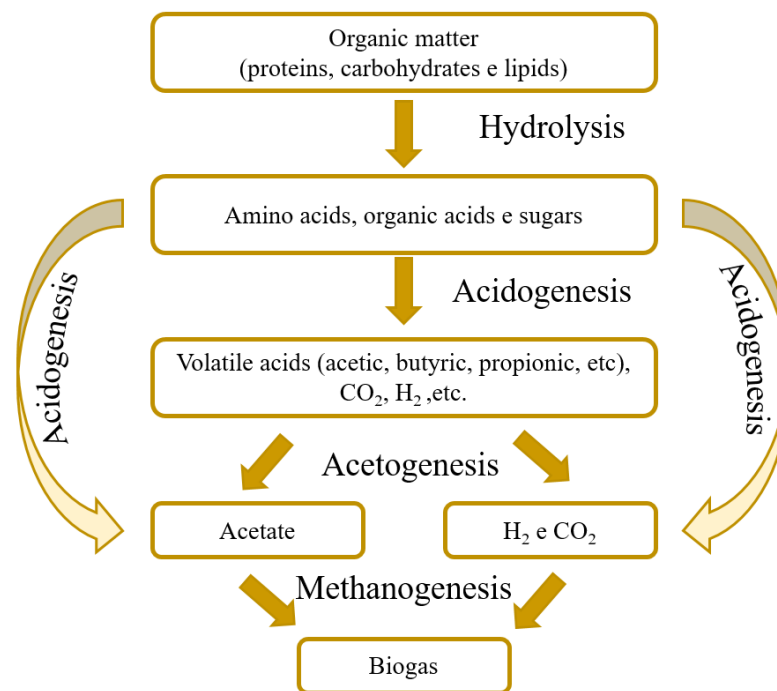

Source: Adapted from Appels *et al* (2008) and Cremonez *et al* (2021)

The hydrolysis occurs in the first step, where carbohydrates, lipids and proteins are hydrolyzed to sugars, fatty acids and amino acids, respectively (YANG; ZHANG; HU, 2013). This step occurs through the action of hydrolytic fermentative bacteria that excrete extracellular enzymes, such as cellulases and proteases (FERRY, 1993). In the acidogenesis step, the hydrolysis products are metabolized by fermentative bacteria to simpler compounds, such as

short-chain organic acids, alcohols, carbon dioxide, etc. Then acetogenic bacteria convert the products of acidogenesis to acetate, carbon dioxide and hydrogen (APPELS *et al.*, 2008).

In the last step, microorganisms from the *Archea* domain perform methanogenesis (FERRY, 1993), which are divided into acetoclastic methanogenesis and hydrogenotrophic methanogenesis (YANG; ZHANG; HU, 2013). Within acetoclastic methanogenesis, the most abundant microorganisms belong to the genera *Methanosaeta* and *Methanosarcina*. While within hydrogenotrophic methanogenesis, the genera *Methanobacterium*, *Methanospirillum* and *Methanobrevibacter* are more common (YANG *et al.*, 2014).

Acetoclastic methanogenesis microorganisms play an important role in converting acetate into methane and carbon dioxide, in which about 70% of the methane is produced (AYDIN *et al.*, 2015). Due to the important role of organic matter degradation, acetoclastic methanogenesis is the main focus of several studies related to AD inhibition (GHATTAS *et al.*, 2017). AD can be inhibited by substances present in the effluent, such as antibiotics, solvents, metals, dissolved organic nitrogen, pesticides and even by intermediate products from previous steps (AYDIN *et al.*, 2015; CETECIOGLU *et al.*, 2012; CHAKRABORTY; SARKAR; LAHIRI, 2002; SHI; LEONG; NG, 2017; ZHANG *et al.*, 2018). Furthermore, the methanogens dictate the hydraulic retention time (HRT) in anaerobic reactors because of their low growth rate (ROOPNARAIN *et al.*, 2021). Thus, their inhibition associated with low rate growth makes them a limiting step in AD (LEE; KIM; HWANG, 2021).

The efficiency of AD is linked to a healthy and diverse microbial community (ZHANG *et al.*, 2019), particularly methanogens, as mentioned above. Anaerobic reactors as UASB (Upflow Anaerobic Sludge Blanket reactor), AnMBR (anaerobic membrane bioreactor) and digestors are widely used, showing several advantages as biomass retention, low sludge production, low energy expenditure, and biogas production (MAI; STUCKEY; OH, 2018). Furthermore, these reactors require a small installation area, an interesting approach as decentralized WWTPs, applied to treat effluents from hospitals, industries, urban, agro-industrial, etc. (LATIF *et al.*, 2011). However, such effluents have compounds with the potential to inhibit microbial activity. The AD is also applied to stabilize waste activated sludge from municipal WWTPs, which can also have several toxic compounds to the microbial community (YANG; ZHANG; HU, 2013).

To obtain a good process efficiency is necessary to understand how compounds, which have inhibitory potential to microbial communities, act on them. Moreover, several drugs show recalcitrance to conventional biological treatment processes being discharged into surface water. In this sense, it is also necessary to apply or develop strategies to degrade them.

2.5 APPLICATION OF ENZYMES TO REMOVE DRUGS

Enzymes are proteins that have catalytic power. They are biocatalysts present in all living cells, where they act in reactions that make up the pathways of cell metabolism (LEHNINGER; NELSON; COX, 2014). Enzymes have an excellent catalytic power associated with high selectivity for the substrate, raising great interest for applications in industries segments as pharmaceutical, fine chemical, agriculture, food and polymers (BASSO; SERBAN, 2019; KAUSHAL *et al.*, 2018).

We can also highlight the potential application of enzymes to the treatment of effluents. Enzymes present a good degradation rate, come from a biological source, do not present ecotoxicity and the degradation products generally present lower toxicity than the original products (IARK *et al.*, 2019; LEHNINGER; NELSON; COX, 2014; MAJEAU; BRAR; TYAGI, 2010; VARGA *et al.*, 2019). Furthermore, the use of purified enzymes has proved to be very efficient in removing pollutants such as antibiotics, dyes, hormones, and other pollutants present in domestic and industrial effluents (BARRIOS-ESTRADA *et al.*, 2018; BILAL *et al.*, 2019). Moreover, they show potential application in removing drugs, such as antineoplastic agents (PEREIRA *et al.*, 2020; YADAV *et al.*, 2020).

To the best of our knowledge, there are a few studies on the production and application of enzymes to remove anticancer drugs. For example, the enzyme dehydrogenase from *Streptomyces sp.* was applied for doxorubicin degradation in the presence of the cofactor NADH, aiming mainly for medical applications (WESTMAN *et al.*, 2012). Another study describes the production of a recombinant aldo-keto reductase (AKR1C3) from the human liver in *E. coli*, evaluated the DOX degradation to understand the development of resistance anticancer drugs by humans. Although these papers are focused on another field, they support the hypothesis that enzymes can be applied to degrade anticancer drugs. Besides, there are also studies on applying white-rot fungi to degrade anticancer drugs, and their degradation is attributed to enzymes (CASTELLET-ROVIRA *et al.*, 2018; FERRANDO-CLIMENT *et al.*, 2015).

2.5.1 Use of white-rot fungi for degradation of antitumor drugs

In nature, white-rot fungi use lignin as one of their nutrient sources. However, it is first necessary to degrade lignin, which takes place through the excretion of extracellular enzymes. *Pleurotus ostreatus* (Figure 8), *Phanerochaete chrysosporium*, *Trametes versicolor*, *Ganoderma lucidum* and *Irpex lacteus* are some examples of white-rot fungi that have been widely studied for production of enzymes (CASTELLET-ROVIRA *et al.*, 2018; CRUZ-MORATÓ *et al.*, 2014; ESPINOSA-ORTIZ *et al.*, 2016; MIR-TUTUSAUS *et al.*, 2017; PRIETO *et al.*, 2011).

Figure 8. White-rot fungi from the species *Pleurotus ostreatus*.



Source: From the author

The mechanisms of removal and/or degradation of drugs by white-rot fungi are shown in Figure 9. Naghdi *et al* (2018) discuss these mechanisms, which can occur in three ways: adsorption on biomass, degradation by intracellular enzymes and degradation by extracellular enzymes.

Figure 9. Mechanisms of drugs removal and/or degradation by white-rot fungi.

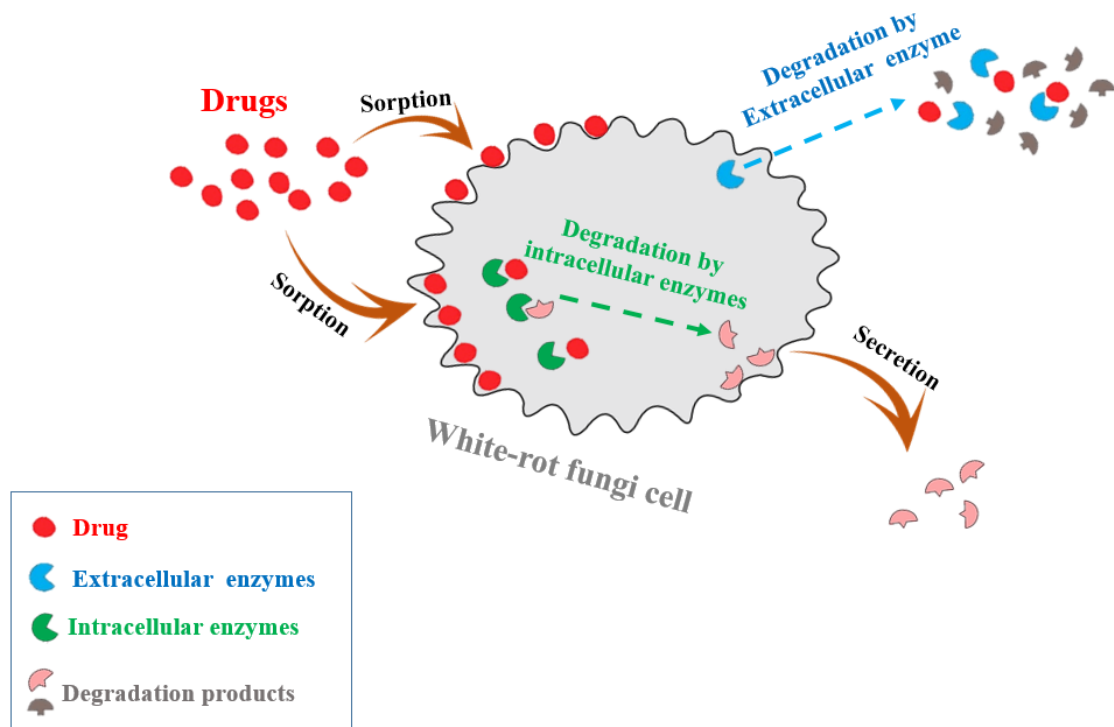

Source: Adapted from Naghdi *et al.* (2018)

Biomass sorption is affected by factors such as pH, temperature and effluent composition, as well as the molecular structure of the drug (NAGHDI *et al.*, 2018a; RODARTE-MORALES *et al.*, 2011). Degradation by extracellular enzymes occurs mainly through the secretion of ligninolytic enzymes, such as manganese peroxidases, lignin peroxidases and laccases (CASTELLET-ROVIRA *et al.*, 2018; MARTÍNEZ *et al.*, 2005; NAGHDI *et al.*, 2018a). These enzymes have as main characteristic the non-specificity for the substrate oxidizing them through the generation of radical (GIARDINA *et al.*, 2010). By producing enzymes, white-rot fungi can degrade not only lignin but also a wide range of substrates (BILAL *et al.*, 2019; MARTÍNEZ *et al.*, 2005). Studies show efficiency in degrading compounds such as dyes, pesticides and some pharmaceutical products such as hormones, antibiotics and even anticancer drugs (ESPINOSA-ORTIZ *et al.*, 2016). Table 3 presents recent studies of anticancer drug removal by white-rot fungi.

Table 3. Studies that use whit-rot fungi to degrade antineoplastic drugs.

Fungus	Degradation attributed to enzyme	Anticancer drug	Concentration ($\mu\text{g}\cdot\text{L}^{-1}$)	Time (days)	Removal (%)	Reference
<i>Ganoderma lucidum</i>	Laccase	Cyclophosphamide	~60	6	<40	Castellet-Rovira <i>et al.</i> , (2018)
		Ifosfamide	~60			
<i>Irpex lacteus</i>	Laccase	Cyclophosphamide	~60	6	<40	Castellet-Rovira <i>et al.</i> , (2018)
		Ifosfamide	~60			
<i>Trametes hirsuta</i>	Laccase	Cyclophosphamide	0,02/0,1/0,5	5	<40	Haroune <i>et al.</i> , 2014
		Ifosfamide	20/100/500			
<i>Trametes versicolor</i>	Laccase	Azathioprine	0,055	9	100	Ferrando-Climent <i>et al.</i> , (2015)
		Cyclophosphamide	~60	6	<40	Castellet-Rovira <i>et al.</i> , (2018)
			10000	9	-	Ferrando-Climent <i>et al.</i> , (2015)
		Etoposide	198	8	100	Ferrando-Climent <i>et al.</i> , (2015)
		Ifosfamide	~60	6	<40	Castellet-Rovira <i>et al.</i> , (2018)
			77	8	61	Ferrando-Climent <i>et al.</i> , (2015)
		Tamoxifen	45	8	48	Ferrando-Climent <i>et al.</i> , (2015)
			300	9	99	Ferrando-Climent <i>et al.</i> , (2015)

Adapted from Pereira *et al.* (2020)

Ferrando-Climent *et al* (2015) evaluated the biodegradation by fungi of anticancer drugs from hospital effluent and obtained complete removal of azathioprine, etoposide and tamoxifen. The authors also compared the degradation of the drug tamoxifen present in wastewater from the hospital and in synthetic solution. The achieved removal was 48% and 99%, respectively. This work demonstrates that the process conditions need further studies for a real application but already indicate the degradation of tamoxifen by white-rot fungi.

The removal of cyclophosphamide and ifosfamide drugs was less than 40% both in synthetic and real effluents for all fungi species (*Ganoderma lucidum*, *Irpex lacteus*, *Trametes hirsuta* and *Trametes versicolor*), which indicates recalcitrance even to this alternative removal process (CASTELLET-ROVIRA *et al.*, 2018; FERRANDO-CLIMENT *et al.*, 2015; HAROUNE *et al.*, 2014).

It is also worth highlighting three important points: 1) The long time required for efficient degradation (up to 9 days), making the application of this technology difficult in several aspects. 2) Since it is necessary to promote the growth of fungi and also provide conditions for them to be metabolically active, it is necessary to add nutrient sources even in real effluents (CRUZ-MORATÓ *et al.*, 2014; FERRANDO-CLIMENT *et al.*, 2015), which greatly increases the cost of implementation. 3) The degradation of these drugs was attributed to a specific enzyme, laccase, which opens new directions to the application of this enzyme (free or immobilized) for the degradation of these drugs.

2.5.2 Potential application of laccase to remove anti-tumor drugs

Laccases (LC) are an enzyme belonging to the oxidoreductase class, which the *Enzyme Commission Number* is EC 1.10.3.2 (BARRIOS-ESTRADA *et al.*, 2018). It is found in several living beings such as bacteria, fungi, plants and even insects, mainly found as an extracellular enzyme. However, intracellular LCs have also been detected (BAILEY *et al.*, 2004).

The main substrates to LC are phenolic compounds. Nevertheless, LC shows no substrate specificity, degrading compounds as aromatic amines and related substances, thiol groups, diamines, N-heterocycles and phenothiazines (BARRIOS-ESTRADA *et al.*, 2018; GIARDINA *et al.*, 2010). Moreover, they use molecular oxygen as a co-substrate for catalysis and produce water as by-product (UNUOFIN; OKOH; NWODO, 2019). Thus, they show advantages regarding to industrial and environmental application, compared to other

oxidoreductases such as peroxidases (which require a supply of H_2O_2) (SPERANZA *et al.*, 2005).

The catalytic site has 4 catalytic centers (4 copper atoms) classified as types 1, 2 and 3 (Figure 10). The type 1 catalytic center (T1) has a copper atom responsible for oxidizing the substrate. T1 then donates the oxidized electrons from the substrate to the catalytic centers T3, and electron transfer occurs internally. After that, T2 reduces molecular oxygen, and the product of this reaction is water (BARRIOS-ESTRADA *et al.*, 2018; SENTHIVELAN; KANAGARAJ; PANDA, 2016; VARGA *et al.*, 2019).

Figure 10. Scheme demonstrating substrate oxidation by laccase from *Trametes Versicolor* with crystallographic structure obtained from Protein Data Bank (PDB ID: 1KYA)

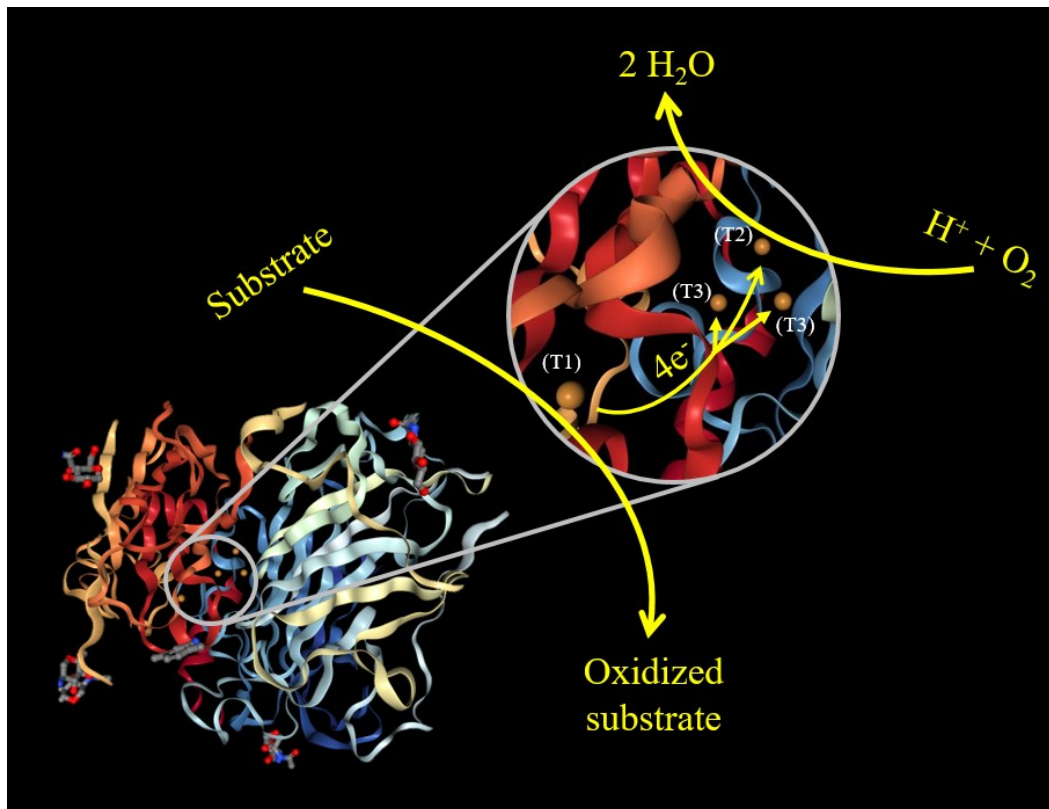

Source: Crystallographic structure obtained from the Protein Data Bank (PDB ID: 1KYA).
Representation of the degradation of the substrate from the author.

It is necessary to oxidize 4 substrates (in T1), generating 4 electrons and 4 radicals. After, there is a reduction in T2 and T3, and the 4 electrons react and produce two water molecules. The formation of radicals in the substrate is generally unstable. Thus, the second stage of enzymatic catalysis can occur, where a quinone is generated, or a spontaneous disproportionation, where hydroquinone is then generated (NAGHDI *et al.*, 2018a).

Due to its versatility, LC can oxidize, polymerize and/or transform various compounds (SIMÓN-HERRERO *et al.*, 2019). Hence, its applications in various industry segments are reported, such as food, biotechnology, pharmaceutical, textile, paper, and even environmental field (aiming to remove pollutants) (BILAL *et al.*, 2019; SENTHIVELAN; KANAGARAJ; PANDA, 2016).

In the treatment of effluents, the oxidation products generated by LC are described as molecules with less toxicity and, consequently, less environmental risk (MAJEAU; BRAR; TYAGI, 2010; SIMÓN-HERRERO *et al.*, 2019). For example, the oxidation of tetracycline and oxytetracycline by LC significantly reduces the antimicrobial activity of both antibiotics (YANG *et al.*, 2017). Another example is the degradation of the RBBR dye (Remazol Brilliant Blue R), which reduced the phytotoxicity of the dye after degradation (OSMA; TOCA-HERRERA; RODRÍGUEZ-COUTO, 2010). Thus, LC have the potential to remove anticancer drugs that have high toxicity and recalcitrance.

2.6 FINAL CONSIDERATIONS

Many works have been reported over the past few years on the rising concern of EPs in the environment. Pharmaceutical products as anticancer drugs represent high toxicity and might be harmful also to the microbial community from WWTPs. Thus, it is necessary to understand if these drugs can cause damage or alteration in the microbial community, especially those are limiting steps to achieve efficient nutrient removal. The effect of anticancer drugs on and enriched archaeas culture from AD was not reported yet. Therefore, it will help to understand how these drugs affect the microbial community from a decentralized WWTP treating wastewater from a hospital.

Anticancer drugs show the potential to inhibit microbial communities from WWTPs. However, they also present high recalcitrance to biological processes. Therefore, it is necessary to apply alternative strategies for removing these compounds from the effluent, avoiding the damage they can cause if they reach the environment. Regarding the removal, the application of enzymes has been shown as an interesting approach. Due to the non-specificity to the substrate, LC are promissory enzymes to treat effluents that have several drugs in the composition. To the best of our knowledge, we are researching novel directions on applying enzymes for the removal of anticancer drugs.

Chapter
3

Inhibitory impact of the anticancer drug
doxorubicin on anaerobic microbial
community

In this chapter, the effect of doxorubicin over an enriched culture of methanogenic archaea was evaluated regarding biogás production, sorption of DOX to the biomass, and the relative abundance of the microbial community was also discussed

3 INHIBITORY IMPACT OF THE ANTICANCER DRUG DOXORUBICIN ON ANAEROBIC MICROBIAL COMMUNITY

ABSTRACT

The inhibitory effect of the anticancer drug doxorubicin (DOX) on biogas production was evaluated in short-term and long-term exposure assays. The short-term assays reached the DOX IC_{50} value on $648 \pm 50 \mu\text{g}\cdot\text{L}^{-1}$. In addition, it was found that inhibition caused by the exposure of $10 \times 10^3 \mu\text{g}\cdot\text{L}^{-1}$ was reversible once DOX was removed from the feeding synthetic medium. Furthermore, DOX can be rapidly sorbed by the biomass (despite the low K_{ow}), contributing to the inhibitory effect. The results of long-term exposure assays showed that when the DOX volumetric loading rate was increased from $100 \mu\text{g}_{\text{DOX}}\cdot\text{L}^{-1}\cdot\text{day}^{-1}$ to $200 \mu\text{g}_{\text{DOX}}\cdot\text{L}^{-1}\cdot\text{day}^{-1}$, the biogas production and COD removal decreased rapidly. However, the methanogenic archaeas could adapt to these conditions, corroborating the results of short-term exposure assays. In conclusion, DOX can play a key role in inhibiting biological wastewater treatment processes if its concentration in hospital wastewater treatment plants increases abruptly.

3.1 INTRODUCTION

Pharmaceuticals are xenobiotic compounds administered in humans and animals (LI, 2014; LUO *et al.*, 2020). They have been found in wastewater, surface water, groundwater, and even drinking water (GOGOI *et al.*, 2018). Among them, anticancer drugs have been reported due to their hazardous and toxicological effects (SANTANA-VIERA *et al.*, 2019). It is well known that these compounds have carcinogenic, mutagenic, toxic and teratogenic potential effects (ČESEN *et al.*, 2015; NEGREIRA; LÓPEZ DE ALDA; BARCELÓ, 2013). Therefore this class of drugs can cause serious damage to the ecosystem, even at low concentrations (ZAIDI, 2019). The anticancer drugs and their degradation products have been detected at concentrations ranging from nanograms to micrograms per liter (NEGREIRA; DE ALDA; BARCELÓ, 2014). Several anticancer drugs have already been detected into environmental samples worldwide (ISIDORI *et al.*, 2016; LENZ *et al.*, 2005; NEGREIRA; DE ALDA; BARCELÓ, 2014; VYAS; TURNER; SEWELL, 2014; YIN *et al.*, 2010). These compounds are difficult to remove through conventional wastewater treatment plants (WWTPs) (FRANQUET-GRIELL *et al.*, 2017; OLALLA *et al.*, 2018). Some drugs such as etoposide, ifosfamide, cyclophosphamide, doxorubicin, tamoxifen are not removed after conventional biological treatment and can be released after wastewater treatment (BOOKER *et al.*, 2014; LÓPEZ-SERNA *et al.*, 2013).

These drugs can be biodegraded bioaccumulated, sorbed into solids, or pass through the WWTPs unchanged (SANTANA-VIERA *et al.*, 2016). They are complex molecules and have the most varied mechanisms of action in multicellular organisms (such as DNA intercalants, antimetabolites, crosslinking agents, among others) (NUSSBAUMER *et al.*, 2011). However, the mechanisms of action in microorganisms are unclear or unknown (ZHANG *et al.*, 2013), and they may interfere in the microbial community. A wide range of these antineoplastic drugs comes from microbial metabolites, which are antibiotics with antitumor activities (GRENNI; ANCONA; BARRA CARACCIOLO, 2018). Some examples are anthracyclines, bleomycin, dactinomycin, and mithramycin (DEMAIN; SANCHEZ, 2009). Thus, they may have antimicrobial properties being able to inhibit the activity of bacteria. The effect of these drugs on bacteria in the intestinal mucosa was already studied, showing alteration on relative abundance and dose-dependent inhibition (FLÓREZ *et al.*, 2016; TANG *et al.*, 2017). The doxorubicin (DOX) has shown IC_{50} values ranging from 1 to $64 \text{ mg}\cdot\text{L}^{-1}$ depending on the bacteria strain (FLÓREZ *et al.*, 2016). An osmosis anaerobic membrane bioreactor (FO-AnMBR) was used to treat a mix of 8 drugs (azathioprine, cyclophosphamide, doxorubicin,

epirubicin, flutamide, methotrexate, mitotane, and tamoxifen). The concentration of $100 \mu\text{g}\cdot\text{L}^{-1}$ caused an increase in the concentration of extracellular polymeric substances and inhibited microbial metabolism (WU *et al.*, 2017). It is known that anticancer drugs can be excreted both in feces and urine (in their original form and/or as metabolites) going directly to the WWTPs (FRANQUET-GRIELL *et al.*, 2015). However, few studies report the effect that these drugs can cause on the microbial community from WWTPs. They have a complex microbial community, and the inhibition of a single group of bacteria can cause an imbalance in the entire microbial community (ZHANG *et al.*, 2019). Therefore, the wastewater treatment might have the efficiency affected (LUO *et al.*, 2020).

Anaerobic digestion (AD) is widely used for effluent treatment, sludge stabilization and industrial effluent treatment (YANG *et al.*, 2014; YANG; ZHANG; HU, 2013; ZHANG *et al.*, 2019). In addition, anaerobic reactors show advantages compared with aerobic ones, as smaller installation areas are required, they can be used for decentralized treatment, such as hospitals (MAI; STUCKEY; OH, 2018). Several microorganisms are involved in AD, from the initial hydrolyze to biogas formation (CREMONEZ *et al.*, 2021). The last stage of AD is methanogenesis, performed by a group of microorganisms belonging to the archaea domain (FERRY, 1993). In this step, the acetate is converted to methane through the acetoclastic methanogenic archaea (CETECIOGLU *et al.*, 2012). If any compound and/or environmental condition inhibits the methanogenic activity, the entire treatment may be compromised (SHI; LEONG; NG, 2017). Methanogenesis can be considered a limiting step in the AD, once can be inhibited by substances present in the influent, such as antibiotics, solvents, metals, dissolved organic nitrogen, pesticides, even intermediate products from previous steps as volatile fatty acids (AYDIN *et al.*, 2015; CETECIOGLU *et al.*, 2012; CHAKRABORTY; SARKAR; LAHIRI, 2002; SHI; LEONG; NG, 2017; ZHANG *et al.*, 2018). Maintaining a metabolically active methanogenic population is necessary for a successful anaerobic digestion process (AYDIN *et al.*, 2015).

In the present study, the main purposes were to investigate the effects of the anticancer drug DOX on a microbial community responsible for the acetoclastic methanogenesis in the AD. The enriched community of acetoclastic methanogenic microorganisms was exposed to DOX in short-term assays. We also investigated the effect of DOX on long-term exposure through biogas production, COD and DOX removal, as well as the effect on the microbial community dynamic.

3.2 MATERIALS AND METHODS

3.2.1 Chemicals

Doxorubicin hydrochloride ($\geq 98\%$) and doxorubicin hydrochloride (secondary standard) were obtained from Sigma Aldrich Brazil and Bergamo, respectively. The other chemicals (all analytical grade) were purchased from Neon (Brazil) and used to prepare synthetic medium or solutions for the analysis.

3.2.2 Inoculum

The anaerobic biomass used in the assay was obtained from a lab-scale reactor (see Figure S1), which was operated for 198 days before the inoculum was harvested. The working reactor volume was 25 L, operating in mesophilic conditions at organic loading rates (OLR) of $1 \text{ kgCOD/m}^3\cdot\text{d}$, pH of 7.8 ± 0.2 , and COD removal of $90 \pm 5\%$ (more data can be found in supplementary material in Figure S2 and Table S1). A synthetic medium was used to feed both the reactor in which the biomass was taken and the batch assays. The medium composition was adapted from the literature, aiming to select archaea responsible for the acetoclastic methanogenesis step from the AD (ZEIKUS, 1977; ZINDER *et al.*, 1984). The synthetic medium consisted of acetate (0.2 to $1 \text{ gCOD}\cdot\text{L}^{-1}\cdot\text{day}^{-1}$), macronutrients and micronutrient solutions (Table 4). The feed solution pH was adjusted to 7.4 by using KOH or HCl 2M.

Table 4. Composition of the synthetic medium used to select archaees and feeding the reactors. The medium pH was adjusted to 7.4 using KOH.

Chemical		Concentration ($\text{g}\cdot\text{L}^{-1}$)
Macronutrients	CH_3COONa	From 0.4 to $1 \text{ gCOD}\cdot\text{L}^{-1}\cdot\text{d}^{-1}$
	KH_2PO_4	0,5
	K_2HPO_4	0,5
	NH_4Cl	0,9
	$\text{MgSO}_4\cdot\text{H}_2\text{O}$	0,2
	$\text{CaCl}_2\cdot\text{H}_2\text{O}$	0,05
Chemical		Concentration ($\text{mg}\cdot\text{L}^{-1}$)
Micronutrients	Nitrilotriacetic acid	10
	$\text{FeCl}_2\cdot 4\text{H}_2\text{O}$	3,60
	$\text{MnCl}_2\cdot 4\text{H}_2\text{O}$	0,90
	$\text{CoCl}_2\cdot 6\text{H}_2\text{O}$	1,53
	ZnCl_2	0,90
	H_3BO_3	0,15
	$\text{CuSO}_4\cdot 4\text{H}_2\text{O}$	0,08
	$\text{Na}_2\text{SeO}_3\cdot 5\text{H}_2\text{O}$	0,20
	$\text{NiCl}_2\cdot 6\text{H}_2\text{O}$	0,10
	Na_2MoO_4	0,50

3.2.3 Short-term exposure assays

In order to determine the effect of short-term exposure to DOX, batch experiments were carried out evaluating the biogas production rate. The biomass was taken from the reactor and mixed with synthetic medium and DOX solution in a 50 mL serum bottle, resulting in an inoculum of $2 \text{ g}_{\text{VSS}} \cdot \text{L}^{-1}$ and $1 \text{ g}_{\text{COD}} \cdot \text{L}^{-1}$ of the substrate. DOX was added to the final concentration of 0; 50; 500; 1×10^3 ; 5×10^3 and $10 \times 10^3 \text{ } \mu\text{g} \cdot \text{L}^{-1}$. A blank was also set up using the same inoculum and synthetic medium, without acetate and without DOX. The serum bottles were purged with argon gas for 2 min to remove all the oxygen and sealed with a rubber stopper. Five replicates for each experiment were carried out and kept in an incubator at $32 \pm 1 \text{ } ^\circ\text{C}$ until there was no biogas production on most of the experiments. The biogas was measured once a day using calibrated glass syringes. The inhibition of biogas production was calculated as shown in Equation 1, where SBPR is the specific biogas production rate.

$$\text{Inhibition (\%)} = \frac{SBPR_{\text{control}} - SBPR_{\text{assay}}}{SBPR_{\text{control}}} \times 100 \quad \text{Equation 1}$$

3.2.4 Sequential batch assays with and without DOX exposure

The microorganisms were exposed abruptly and temporarily to DOX to verify if they can survive this stress condition. The concentrations which showed an inhibitory effect on short-term exposure assays were used in this experiment. The assays were carried out in sequential batch assays, called cycles (1^o cycle: with exposure to DOX; 2^o and 3^o cycles: without exposure to DOX), each cycle was carried out for 13 days. After 1^o cycle, the biomass was centrifuged at 3000 rpm for 5 min, and the supernatant was discharged. The microorganisms were then cultivated in a synthetic medium without DOX (2^o cycle). The same procedures were carried out to 3^o cycle. The biogas production was measured every day.

3.2.5 Abiotic test

The contribution of DOX removal by sorption was evaluated on inactivated microorganisms. The biomass was autoclaved at $121 \text{ } ^\circ\text{C}$ for 10 min, in order to inactivate the biomass (GROS *et al.*, 2014; PIERRE; MAUD; BENOÎT, 2014). The assays were carried out in a synthetic medium, with $2 \text{ g}_{\text{VSS}} \cdot \text{L}^{-1}$ of inactivated biomass, and $2500 \text{ } \mu\text{g} \cdot \text{L}^{-1}$ of DOX. The abiotic hydrolysis were carried out as control in a synthetic medium, with $2500 \text{ } \mu\text{g} \cdot \text{L}^{-1}$ of DOX, and without biomass. This assay was performed in order to ensure the sorption into the biomass.

The reported results are the average values from four assays replicates with two measurements of DOX concentration at each replicate. Once the DOX is a fluorescent compound, images of its sorption into the biomass were captured with a LEICA DMI6000 confocal microscope (CACICEDO *et al.*, 2015).

3.2.6 Log-term exposure assay

For the long-term exposure assay, microorganisms were exposed to DOX concentration under IC_{50} values determined during the short-term exposure. The assays were carried out for 110 days, in a 50 mL serum bottle (Figure S1, supplementary material), at 32 ± 1 °C, and hydraulic retention time (HRT) of 5 days. Five serum bottles were operated as replicates. The flasks were fed manually once a day, for that 10 mL of supernatant was taken from the flask using a calibrated syringe and 10 mL of the synthetic medium was added. The whole experiment was divided in 5 different feeding conditions:

- I) Feeding of $0.2 \text{ g}_{\text{COD}} \cdot \text{L}^{-1} \cdot \text{day}^{-1}$ without the presence of DOX;
- II) Feeding of $0.2 \text{ g}_{\text{COD}} \cdot \text{L}^{-1} \cdot \text{day}^{-1}$ and $100 \text{ } \mu\text{g}_{\text{DOX}} \cdot \text{L}^{-1} \cdot \text{day}^{-1}$;
- III) Feeding of $0.4 \text{ g}_{\text{COD}} \cdot \text{L}^{-1} \cdot \text{day}^{-1}$ and $100 \text{ } \mu\text{g}_{\text{DOX}} \cdot \text{L}^{-1} \cdot \text{day}^{-1}$;
- IV) Feeding of $0.4 \text{ g}_{\text{COD}} \cdot \text{L}^{-1} \cdot \text{day}^{-1}$ and $200 \text{ } \mu\text{g}_{\text{DOX}} \cdot \text{L}^{-1} \cdot \text{day}^{-1}$;
- V) Feeding of $0.4 \text{ g}_{\text{COD}} \cdot \text{L}^{-1} \cdot \text{day}^{-1}$ and $100 \text{ } \mu\text{g}_{\text{DOX}} \cdot \text{L}^{-1} \cdot \text{day}^{-1}$.

The biogas production, doxorubicin concentration, COD removal, and pH was monitored periodically.

3.2.7 16S rRNA gene amplification and sequencing

At the end of the long-term exposure assay (110 days), the biomass was centrifuged at 6000 rpm, and 4°C for 10 min. The samples were frozen at -80 °C, and, subsequently, sent for analysis. The DNA purification and extraction, sample molecular preparation, and high-performance sequencing of the V3–V4 region of the 16S rRNA gene (Illumina MiSeq) were performed by Neopropecta Microbiome Laboratory – Florianópolis city/Brazil (CHRISTOFF *et al.*, 2017). Briefly, the DNA extraction was carried out following a protocol (Neopropecta Microbiome Technologies, Florianópolis, SC, Brazil), details of which are subject to intellectual property rights. The DNA was quantified on a Qubit fluorimeter with the dsDNA BR assay kit (Invitrogen, Waltham, MA, USA). After quantification, the DNA was diluted to $0.5 \text{ ng } \mu\text{L}^{-1}$ and stored at -20 °C for molecular analyses. Preparation of libraries followed a protocol (Neopropecta Microbiome Technologies, Florianópolis, SC, Brazil), details of which are subject to intellectual property rights. Amplification was performed with the specific

primers for the V3–V4 region of 16S rRNA, 341F (5'-CCTACGGGGRSGCAGCAG-3'), and 806R (5'-GGACTACHVGGGTWTCTAAT-3') (CAPORASO *et al.*, 2011; WANG; QIAN, 2009). The libraries were sequenced through the MiSeq Sequencing System (Illumina Inc., San Diego, CA, USA) using standard primers supplied by the manufacturer with 500 cycles and paired-end sequencing

3.2.8 Analytical methods

The biogas volume was measured using calibrated glass syringes (MAI; STUCKEY; OH, 2018), and biogas production was calculated according to Equation 2.

$$V_N = \frac{V_b \times (P + P_w) \times T_0}{P_0 \times T} \quad \text{Equation 2}$$

Where V_N is the volume of the gas in the normal state (mL_N). V_b is the volume of the gas as read off (mL). P is the pressure of the gas phase at the time of reading (mbar). P_w is the vapor pressure of the water as a function of the room temperature (mbar). T_0 is the normal temperature (273 K). P_0 is the normal pressure (1013 mbar). T is the temperature of the fermentation gas of the ambient space, in K.

The DOX quantification was carried out by a fluorescence spectrophotometer (KELBERT *et al.*, 2021). Briefly, samples were filtered (0.22 μm pore size membrane), and DOX measurements were carried in fluorescence spectrophotometer (SpectraMax[®] GeminiTM EM, Molecular devices[®]). The sample volume of 200 μL was added in 96-well black plates (Corning incorporated Costar[®]) and then read. The excitation and emission wavelengths were 480 and 598 nm, respectively. The standard curve was performed in medium to eliminate the interferences (See supplementary data Figure S3).

The determination of Chemical Oxygen Demand (COD) and volatile suspended solids (VSS) was performed according to procedures described by Standard Methods for the Examination of Water and Wastewater (APHA, 2012).

3.3 RESULTS AND DISCUSSION

3.3.1 Doxorubicin affect the biogas production in a concentration-dependent way

Figure 11 shows the results of the short-term biomass exposure to the anticancer drug (DOX). Cumulative biogas production indicated that the rate and levels of biogas production decreased as the DOX concentration increased. Inhibition of biogas production can be seen at concentrations $\geq 500 \mu\text{g}\cdot\text{L}^{-1}$. From the control to the DOX concentration of $500 \mu\text{g}\cdot\text{L}^{-1}$ final biogas production decreased 10%. When the DOX concentration was increased to $1\times 10^3 \mu\text{g}\cdot\text{L}^{-1}$ this decrease in the final biogas production goes to 35.8%.

Figure 11. Biogas production yield for exposure to several doxorubicin concentrations.

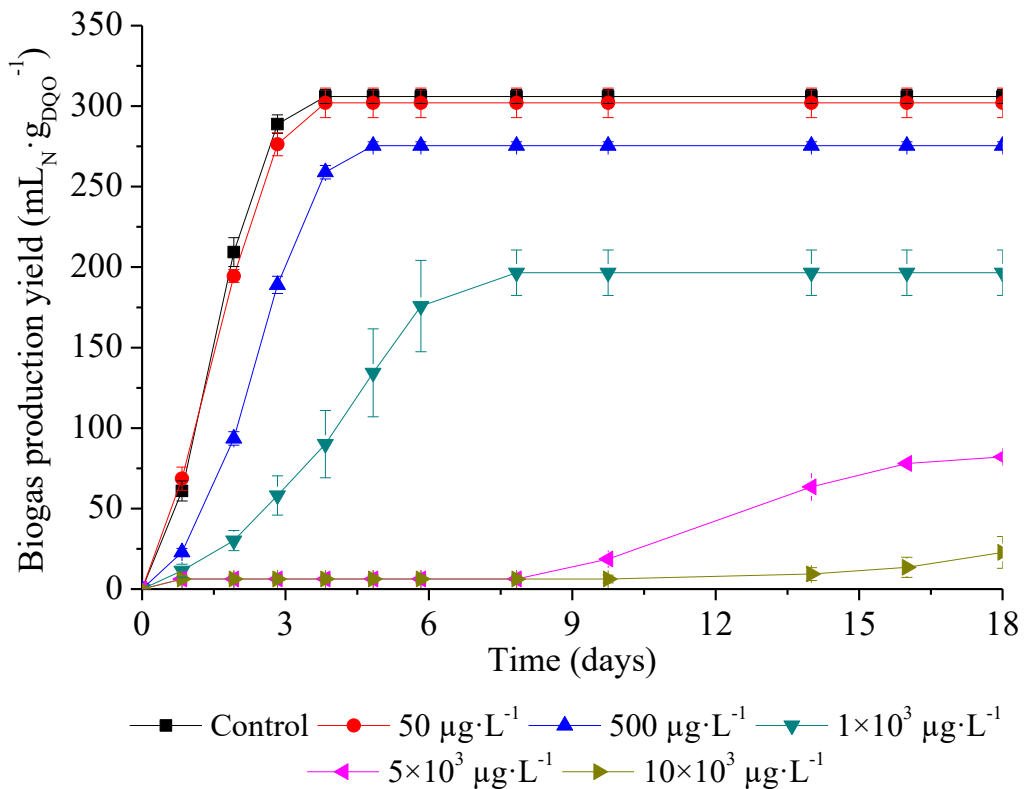

At the concentration of $5\times 10^3 \mu\text{g}\cdot\text{L}^{-1}$ the decrease in the final biogas production reaches 73.2%. The biogas started to be produced just after 10 days of exposure, showing an enlarging lag phase. Meanwhile, the DOX concentration of $10\times 10^3 \mu\text{g}\cdot\text{L}^{-1}$ (even after 18 days) showed 92.6% less biogas production than the control assay. The enlargement of the lag phase (when exposed to a toxicant) was already reported in the literature (FÁBEROVÁ *et al.*, 2019;

WANG *et al.*, 2014). This behavior is concentration-dependent corroborating with the results of this study.

The effect of DOX was also obtained in terms of the inhibition on the specific biogas production rate decrease (Table 5). With 50 $\mu\text{g}\cdot\text{L}^{-1}$ of DOX was already possible to see an inhibition at the rate of 7.3%. When the concentration was increased to 500 $\mu\text{g}\cdot\text{L}^{-1}$ and 1×10^3 $\mu\text{g}\cdot\text{L}^{-1}$, the specific biogas production rate decreased 33.2 and 71.8%, respectively. The increase in the concentration of doxorubicin caused an increase in the inhibition of biogas production, reaching the inhibition of values of $97.9 \pm 0.9\%$ at the concentration of 10×10^3 $\mu\text{g}\cdot\text{L}^{-1}$.

Table 5. Specific biogas production rates and inhibition percentages to different concentrations of doxorubicin

DOX concentration ($\mu\text{g}\cdot\text{L}^{-1}$)	Specific biogas production rate $\text{mLN}\cdot(\text{gCOD}\cdot\text{gVSS}_{\text{inoculum}}\cdot\text{d})^{-1}$	Inhibition (%)
0	53.9 ± 0.7	0
50	49.9 ± 1.1	7.3 ± 2.3
500	35.5 ± 0.7	33.2 ± 1.3
1×10^3	$15.2 \pm 2,8$	71.8 ± 4.7
5×10^3	4.1 ± 0.2	92.5 ± 0.2
10×10^3	1.1 ± 0.5	97.9 ± 0.9

In order to calculate the IC_{50} value, the percentage inhibition values concerning the concentration of doxorubicin were plotted, as shown in Figure 12.

Figure 12. Correlation between the percentage of inhibition of the enriched mixed culture and the concentration of doxorubicin.

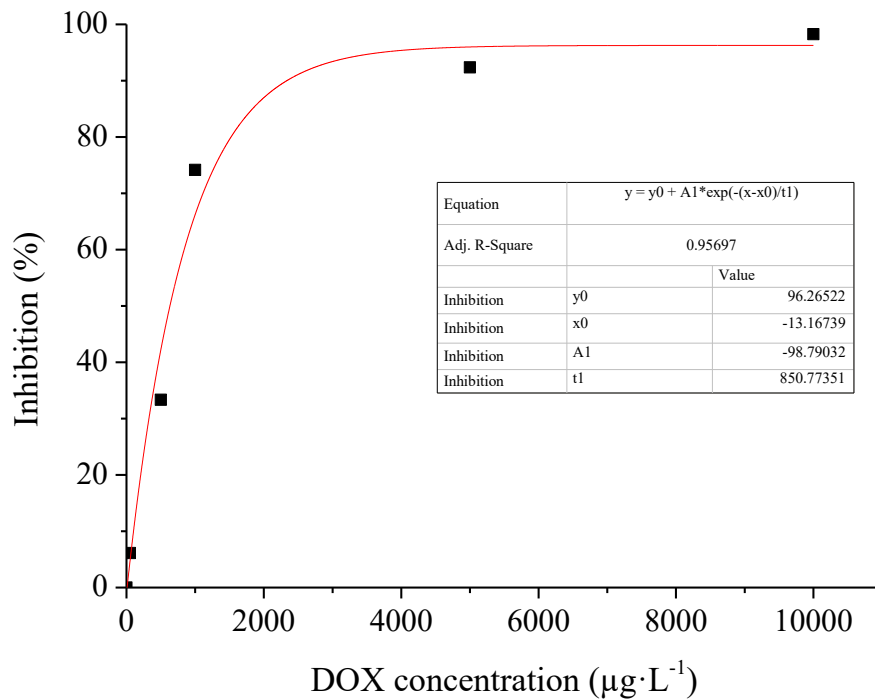

Through a logarithmic fit, an IC_{50} value of $648 \pm 50 \mu\text{g}\cdot\text{L}^{-1}$ was obtained. The IC_{50} value found to DOX is much lower than values already reported to antibiotics, which are well known for their antimicrobial activity. Ciprofloxacin in the concentration of $4.8 \times 10^3 \mu\text{g}\cdot\text{L}^{-1}$ was reported as able to inhibit 50% of the methanogenic activity in sludge from an anaerobic membrane bioreactor (AnMBR) (MAI; STUCKEY; OH, 2018). Meanwhile, the chlortetracycline hydrochloride showed the IC_{50} of $10 \times 10^3 \mu\text{g}\cdot\text{L}^{-1}$ on the methanogenic activity an anaerobic granular sludge (REYES-CONTRERAS; VIDAL, 2015).

Among other anticancer drugs, the anthracyclines (e.g., doxorubicin), are described as antibiotics with antitumor action (DEMAIN; SANCHEZ, 2009). According to Westman *et al.*, (2012), they can induce DNA and/or RNA damage in bacteria, showing similar inhibition mechanisms in animal cells. Thus, supporting the results of this study, which showed the decrease in the biogas production and specific biogas production rate by the exposure to DOX.

3.3.2 Impact of DOX on biogas production after an abruptly and temporally exposure to the drug

The short-term exposure to DOX concentrations of 500, 5×10^3 , and $10 \times 10^3 \mu\text{g}\cdot\text{L}^{-1}$ have resulted in reduction of the biogas production (Figure 11) of 10, 73.2 and 92.6%,

respectively. It was not known if the archaea were able to recover from this inhibition caused by DOX in these assays. Thus, the biomass was submitted to different 3 cycles, the first one was with exposure to DOX. While, in the second and third, the same biomass was resuspended in the medium without DOX.

According to Figure 13, in the 1^o cycle, the biomass shows the same behavior as the assays of short-term exposure (Figure 11). In the 2^o cycle, the supernatant containing DOX was changed by synthetic medium without DOX. As a result, biogas production started to increase. In the 3^o cycle, the microorganisms exposed to $5 \times 10^3 \mu\text{g}\cdot\text{L}^{-1}$ (in the 1^o cycle) were able to recover their activity in terms of biogas production. Meanwhile, the biomass exposed to $10 \times 10^3 \mu\text{g}\cdot\text{L}^{-1}$ (in the 1^o cycle) showed an almost complete recovery.

Figure 13. The biogas production after short-term exposure to DOX or without DOX in three operational cycles. 1^o cycle: short-term exposure to DOX; 2^o cycle and 3^o cycle: resuspended biomass without DOX.

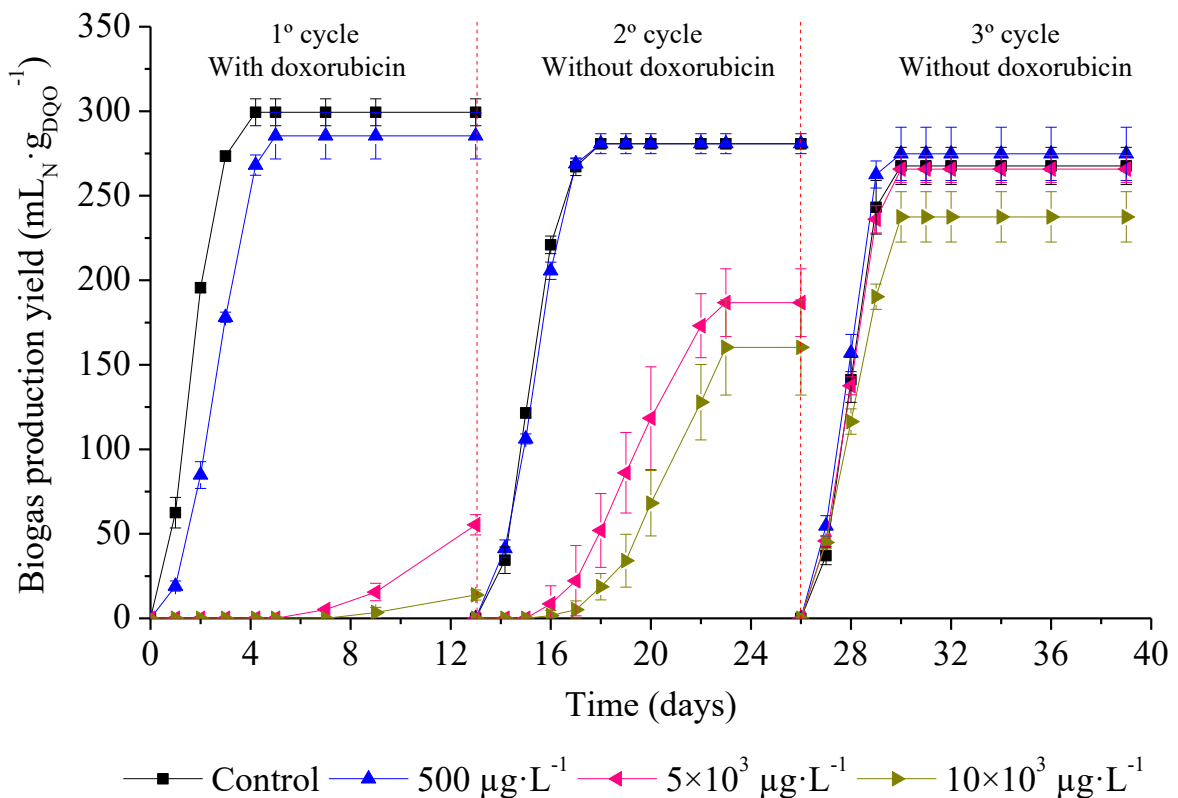

The results indicate that exposure to DOX causes temporary inhibition. The biogas production gradually increased in subsequent cycles after the supernatant containing DOX was removed and synthetic medium without DOX was added. The activity returned almost

completely even to the microorganisms exposure to the DOX concentration of $10 \times 10^3 \mu\text{g} \cdot \text{L}^{-1}$ (in the 1^o cycle). The recovery on biogas production, just in the 3^o cycle, might be because of the sorption of the DOX into the biomass (discussed in item 3.3.3). The results also indicate that cell death is not the main factor in decreasing biogas production in the 1^o cycle. Suggesting that the major contribution is caused by the inhibition of metabolism rather than cell death. The process would recover slower if cell death were the main mechanism of inhibition. The methanogens dictate the hydraulic retention time (HRT) in anaerobic reactors because of their low growth rate (ROOPNARAIN *et al.*, 2021). Thus, their inhibition associated with low rate growth makes them a limiting step in AD (LEE; KIM; HWANG, 2021).

3.3.3 Sorption of doxorubicin to the biomass

The DOX contribution to the inhibition of methanogenic activity might be related to sorption. The bioaccumulation of organic micropollutants into biomass generally occurs by absorption or adsorption (BESHA *et al.*, 2017). The absorption of them into the fatty tissues is the most reported. This mechanism is strongly dependent on the hydrophobicity of the compounds. The absorption happens through hydrophobic interaction between the cell membrane of microorganisms or the sewage and the micropollutant (MAI; STUCKEY; OH, 2018). This characteristic can be measured by the octanol-water partition coefficient (K_{ow}), which represents the ability of a substance to be absorbed by the organic phase or stay in an aqueous solution (ZHANG *et al.*, 2013). Substances that have $\log K_{ow}$ lower than 2.9 are assumed to be poorly to moderate sorbed to sewage sludge (NEGREIRA *et al.*, 2015b). The DOX has a $\log K_{ow}$ of 1.27, indicating poor absorption into anaerobic sludge. However, despite having low K_{ow} and being hydrophilic, DOX was readily sorbed to sludge, as shown in Figure 14 A.

Meanwhile, the adsorption happens when the drugs are ionizable, and an electrostatic attraction occurs between them and other surfaces (BESHA *et al.*, 2017). The DOX has the pKa of 8.2 been positively charged in the pH of the assay, which is 7.4 (WANG *et al.*, 2018). Thus, the main mechanism of sorption of DOX into the biomass might be adsorption. This result can be explained by the electrostatic interactions between the positive charge of the DOX (e.g., amino groups) and the negative charge of the microorganisms cell surface (TERNES; JOSS; SIEGRIST, 2004). Another study corroborated this result, where DOX was mainly removed from the liquid phase by the adsorption into anaerobic sludge (WANG *et al.*, 2018).

Figure 14. Doxorubicin sorption to the inactivated biomass. A) kinetic sorption and hydrolysis, B) bright field microscopy image of the biomass, and C) fluorescence microscopy image of DOX sorbed into the biomass.

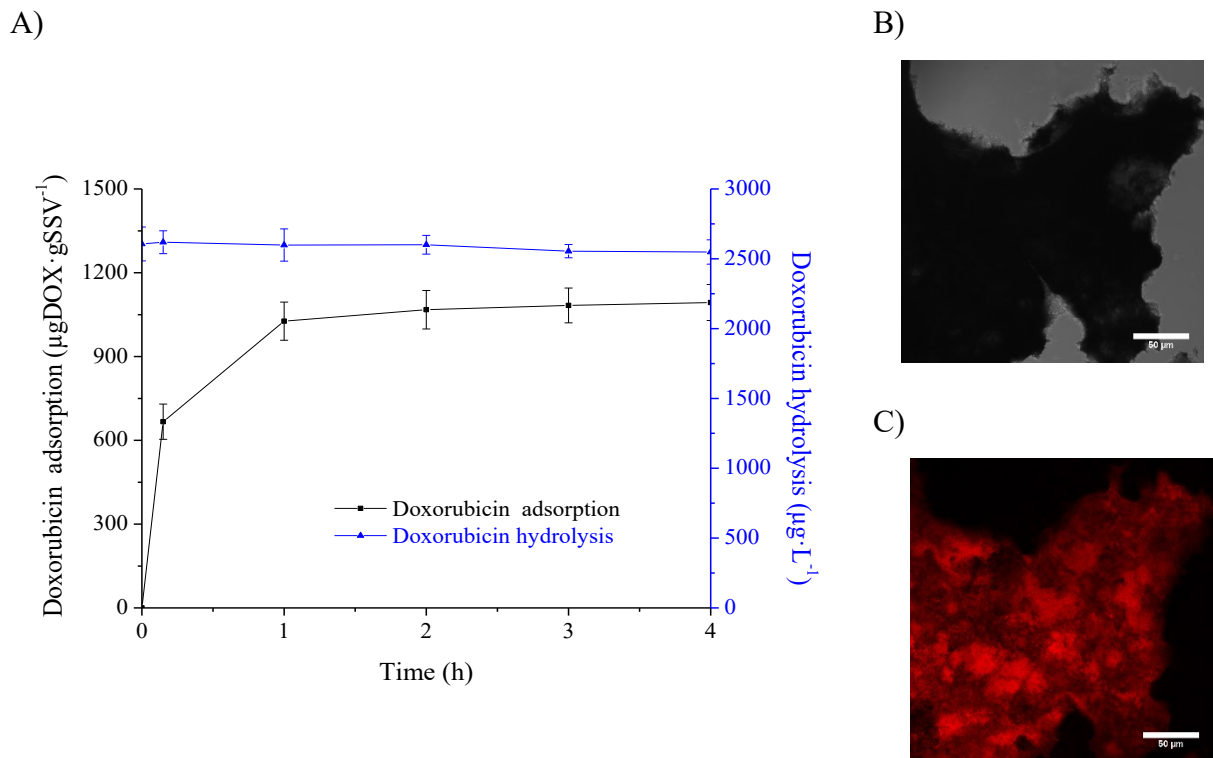

No hydrolysis was observed in the experiment where DOX was added in the medium without biomass (Figure 3 A). Thus, the removal of DOX from the liquid phase can be attributed mainly to the adsorption. In order to confirm it, bright field microscopy and confocal microscopy images were taken from the biomass. Figure 14 B shows an image of the bright field of the biomass granule. When the excitation of 415 nm has applied to the sample, DOX adsorbed in the biomass emits the fluorescence in 485 nm, captured by the microscopy (CACICEDO *et al.*, 2015). As a result, it is possible to visualize the bioaccumulation of DOX on the surface of the granule in the red color (Figure 14 C). Corroborating with the results showed in the sorption kinetic.

3.3.4 Methanogenic long-term exposure to DOX

The biomass was transferred from a reactor operated for 196 days to the reactors (50 mL serum bottle), where the long-term exposure assays were carried out. We would like to emphasize that the reactor was fed for 196 days with a synthetic medium, aiming to select archaea responsible for the methanogenesis (data not shown). The synthetic medium was

designed to represent low-loading municipal wastewater (see item 3.2.2 and 3.2.6.) However, acetate was the carbon source. The adaptation to these reactors was performed by 10 days (phase I), without the addition of DOX at the OLR of $0.2 \text{ g}_{\text{COD}} \cdot \text{L}^{-1} \cdot \text{day}^{-1}$ (Figure 15)

Between day 10 and 30 (phase II), the OLR was kept at $0.2 \text{ g}_{\text{COD}} \cdot \text{L}^{-1} \cdot \text{day}^{-1}$, and DOX started to be added at volumetric loading of $100 \mu\text{g}_{\text{DOX}} \cdot \text{L}^{-1} \cdot \text{day}^{-1}$. At the same concentration range, the damage caused by a pollutant in a long-term exposure might be higher than short-term exposure (LANGBEHN; MICHELS; SOARES, 2020). Thus, the DOX was used initially at this volumetric loading because it is lower than the IC_{50} value obtained for the short-term exposure assay ($648 \pm 50 \mu\text{g} \cdot \text{L}^{-1}$). In this period, the biogas production (Figure 15 A) and the COD removal were stable (Figure 15 B). Meanwhile, the DOX concentration in the effluent (Figure 15 C) gradually increased in the effluent, indicating the saturation of biomass with sorbed DOX. According to Figure 14, the maximum DOX sorption was $1094 \pm 65 \mu\text{g}_{\text{DOX}} \cdot \text{g}_{\text{VSS}}^{-1}$, supporting the result found in this assay. In phase III (starting from day 30), OLR was increased to $0.4 \text{ g}_{\text{COD}} \cdot \text{L}^{-1} \cdot \text{day}^{-1}$. The same behavior was observed in all parameters analyzed.

Figure 15. Effect of DOX on methanogenesis during a long-term experiment: A) Biogas production yield; B) COD removal; and C) Measurement of DOX in the influent and effluent.

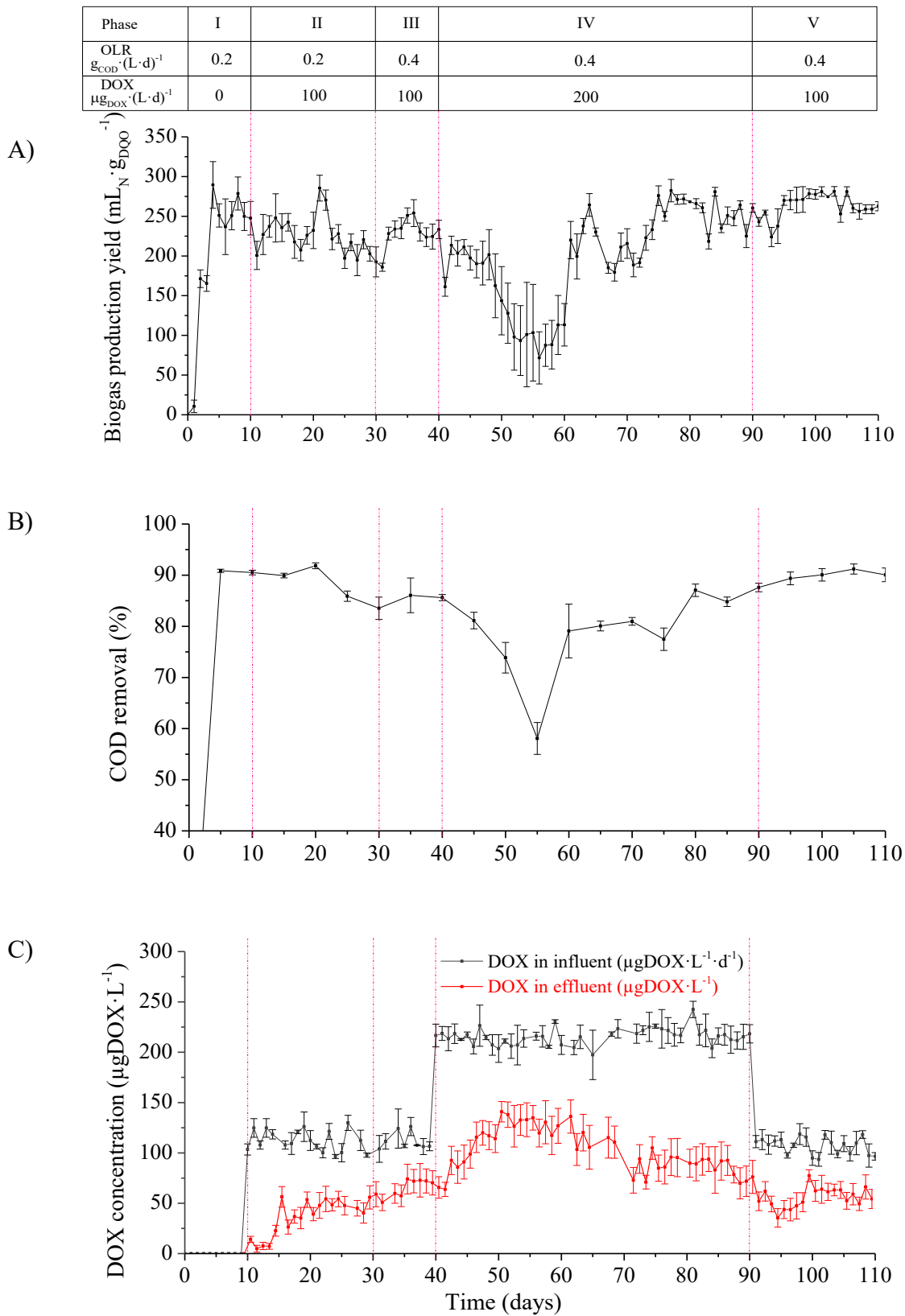

The DOX volumetric loading rate was increased to $200 \mu\text{g}_{\text{DOX}}\cdot\text{L}^{-1}\cdot\text{day}^{-1}$ on the 40th day (phase IV). Biogas production, which was $224 \pm 16 \text{ mL}_{\text{N}}\cdot\text{g}_{\text{COD}}^{-1}$, decreased in the subsequent days until it reached the minimum value of $72 \pm 32 \text{ mL}_{\text{N}}\cdot\text{g}_{\text{COD}}^{-1}$, on 56th day. The COD removal also decrease from $95 \pm 0.9\%$ to $58 \pm 3\%$ in the same period. After this drop-in activity, biogas production and COD removal started to increase again, indicating that the microorganisms could adapt to this DOX concentration and recover their original activity. From the 61st day, the DOX concentration in the effluent started to decrease, even without any change in the feeding of the reactors. In the same period, biogas production started to increase again, which shows the return in microbial activity. A biological degradation might decrease DOX concentration from the effluent and consequently increase in biogas production. The pH of the medium also might help the degradation. Despite the synthetic medium being adjusted to pH of 7.4, the pH in the effluent was stable around 8 during the experiment (Supplementary data Figure S4). The basic pH can also destabilize the DOX molecule and cause degradation (BEIJNEN *et al.*, 1986).

It is well known that the microorganisms might go through an adaptive evolution process to enhance the robustness to pollutants which can inhibit the process (JIANG *et al.*, 2018). At the end of phase IV, the process started to stabilize. After the 90th day (phase V), the volumetric loading of DOX was returned to $100 \mu\text{g}_{\text{DOX}}\cdot\text{L}^{-1}\cdot\text{day}^{-1}$, in order to verify if there was an increase in the biogas production (comparing with phase II and III). The values of biogas production and COD removal and DOX concentration in influent stayed stable in phase V, presenting better performance compared with the results in phases II and III. These results indicate the adaptative evolution of archaeas when in contact with the drug at the concentration of $100 \mu\text{g}_{\text{DOX}}\cdot\text{L}^{-1}\cdot\text{day}^{-1}$.

3.3.5 The microbial community structure after DOX exposure

The synthetic medium used the fed the acclimation reactor was chosen from literature as a medium to select the archaeas, which are responsible for the last step of the AD, converting acetate to biogas (ZEIKUS, 1977; ZINDER *et al.*, 1984). According to Figure 16 A, 84.44% of the relative abundance was composed by archaeas and just 15.56% of the relative abundance was composed by the bacteria domain. This result shows that the enrichment of archeas in the co-cultured biomass was successfully achieved.

Figure 16. Relative abundance of the samples after DOX exposure at day 110 on A) domain and B) genus level. The average of >0.5% of relative abundance are shown.

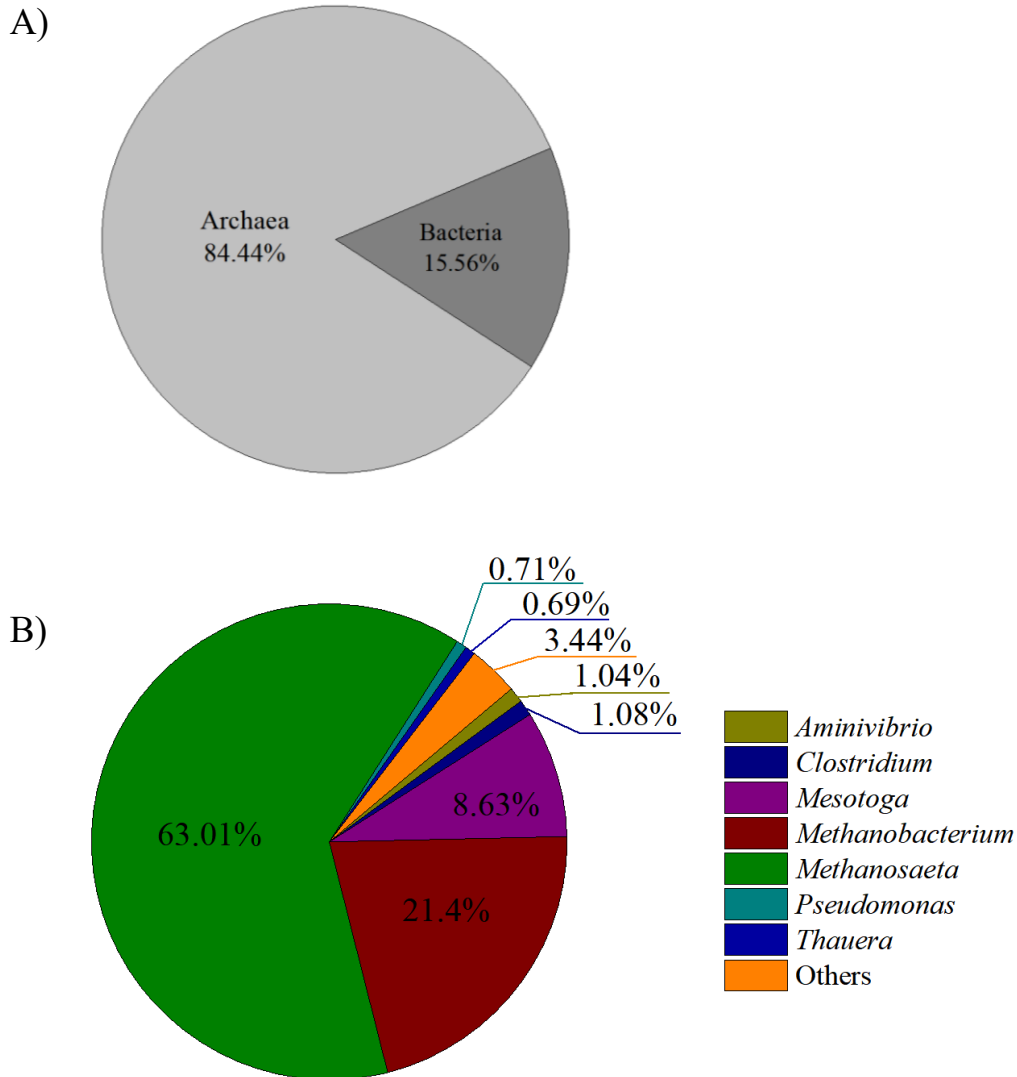

At the genus level, the main archaeas were the *Methanosaeta* and *Methanobacterium*, with 63.01 and 21.4% of relative abundance, respectively (Figure 16 B). Archaeas in AD are divided into archaeas acetoclastic methanogenic and archaeas hydrogenotrophic (CREMONEZ *et al.*, 2021; YANG; ZHANG; HU, 2013). For the acetoclastic, the most abundant microorganisms belong to the genus *Methanosaeta* and *Methanosarcina* (YANG *et al.*, 2014). Despite being the most abundant, *Methanosaeta* genus was the only one present in the biomass. *Methanosaeta* is able to utilize acetate as substrate or participate in the direct interspecies electron transfer (DIET) pathway and produce methane (SHEN *et al.*, 2016). According to (LIU *et al.*, 2019), the genus affects the syntrophic interaction and consequent methanogenic

pathways. Thus, *Methanobacterium* and *Methanosaeta* can perform a similar role as *Methanosarcina*, without interfering in methane efficiency production.

For archaeas hydrogenotrophic, the genus *Methanobacterium* is one of the most common (YANG *et al.*, 2014). Therefore, it was not expected to find the *Methanobacterium* genus (a hydrogenotrophic archaea) in the samples, once the main substrate in the synthetic medium was acetate. In addition to the above discussed, the *Clostridium* genus was found at the relative abundance of 1.08%, which can also justify the presence of the *Methanobacterium*. *Clostridium* can oxidize acetate and produce hydrogen when coupled to hydrogenotrophic methanogens (HATTORI *et al.*, 2000; MAI; STUCKEY; OH, 2018). Meanwhile, the *Methanobacterium* can reduce CO₂ using molecular hydrogen and produce methane (MAI; STUCKEY; OH, 2018). Therefore, these two genus was may be found because the syntrophic pathway between them.

The bacteria domain was composed majority by *Mesotoga* genus, with 8.63% of the relative abundance. The *Mesotoga* are reported as a microorganism able to acetate-oxidizing by an unknown pathway (NOBU *et al.*, 2015). The *Mesotoga* enrichment in a reactor also contributes to high efficiency on COD removal, as shown in Figure 4 B (LIANG *et al.*, 2021). Another study also suggests that *Mesotoga* and *Methanosaeta* do not compete for acetate as substrate. Instead, they cooperate syntrophically through the CO₂ reduction pathway (LIU *et al.*, 2019).

Lastly, the microorganisms in the biomass exposed to DOX are previously described as presenting tolerance to inhibitory conditions. *Methanosaeta* genus is described to robustness showed by the toxicity of long-chain fatty acids (SILVA *et al.*, 2016). The *Methanobacterium* and *Clostridium* abundance were enriched in the presence of a stress condition caused by the antibiotic ciprofloxacin (MAI; STUCKEY; OH, 2018). The *Mesotoga* showed high activity in bioreactors aiming to degrade terephthalate (NOBU *et al.*, 2015).

3.4 PARTIAL CONCLUSIONS

This study showed results that help to understand how the anticancer drug doxorubicin affects a microbial community from WWTPs. The short-term exposure of archaeas to DOX indicated that concentrations $\geq 500 \mu\text{g}\cdot\text{L}^{-1}$ can inhibit this group of microorganisms. Moreover, the drug sorption to biomass might contribute to the inhibitory effect and despite the low K_{OW} present by DOX, the sorption might occur by electrostatic interactions. Furthermore, the

archaeas can adapt to the inhibitory process and recovery after a period of time, suggesting that the inhibition mechanism is not related to microbial cell death. In addition to the environmental risk (already reported in the literature), DOX can also play a key role in inhibiting biological wastewater treatment processes if its concentration in hospital wastewater treatment plants increases abruptly. Moreover, as far as we went with the long-term experiment, it has shown the capability to recover the process after an adaptation period, enabling to operate a WWTP coexisting with this drug. Finally, the main archaeas genus *Methanosaeta* and *Methanobacterium* were found in the biomass and *Mesotoga* genus was the most abundant bacteria.

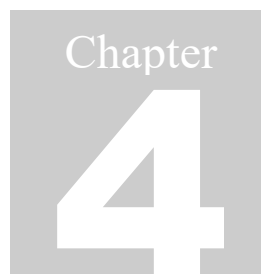
A square graphic with a grey background. The word "Chapter" is written in a white serif font at the top. Below it, the number "4" is written in a large, white, bold sans-serif font.

Laccase as an efficacious approach to remove anticancer drugs: a study of doxorubicin degradation, kinetic parameters, and toxicity assessment

In this chapter, the degradation of doxorubicin by the laccase *from Trametes versicolor* was evaluated. The best experimental conditions of enzyme and doxorubicin concentration, pH and temperature values and toxicity assessment was evaluated.

The paper entitled “**Laccase as an efficacious approach to remove anticancer drugs: a study of doxorubicin degradation, kinetic parameters, and toxicity assessment**” was accepted to publication in the Journal of Hazardous Materials in November 2020 (doi.org/10.1016/j.jhazmat.2020.124520).

4 LACCASE AS AN EFFICACIOUS APPROACH TO REMOVE ANTICANCER DRUGS: A STUDY OF DOXORUBICIN DEGRADATION, KINETIC PARAMETERS, AND TOXICITY ASSESSMENT

ABSTRACT

The degradation of antineoplastic drug doxorubicin was studied applying an enzymatic approach. For the first time, free laccase was applied to degrade anticancer drugs. Degradations of doxorubicin by laccase were performed in different enzymatic activities, pH values and temperatures through kinetic studies. The highest enzymatic degradation of doxorubicin was achieved at 30 °C in pH 7, which resembles effluent characteristics from wastewater treatment plants. Assays were carried out in different doxorubicin concentrations for a better comprehension of the enzymatic kinetics of degradation. Michaelis–Menten kinetic parameters obtained were maximum velocity obtained (V_{max}) of $702.8 \mu\text{g}_{\text{DOX}} \cdot \text{h}^{-1} \cdot \text{L}^{-1}$ and Michaelis-Menten constant (K_M) of $4.05 \mu\text{M}$, which showed a good affinity for the substrate. The toxicity was evaluated against L-929 cell line, and the degraded doxorubicin solution did not show a reduction in cell viability in the concentration of $250 \mu\text{g} \cdot \text{L}^{-1}$. In contrast, doxorubicin shows a reduction of 27% in cell viability. Furthermore, in the highest tested concentration ($1000 \mu\text{g} \cdot \text{L}^{-1}$), degradation reduced by up 41.4% the toxicity of doxorubicin, which indicates laccase degrades doxorubicin to non-toxic compounds. In conclusion, this study provides a new application to laccase since the results showed great potential to remove anticancer drugs from effluents.

Figure 17. Graphical abstract of the chapter 4

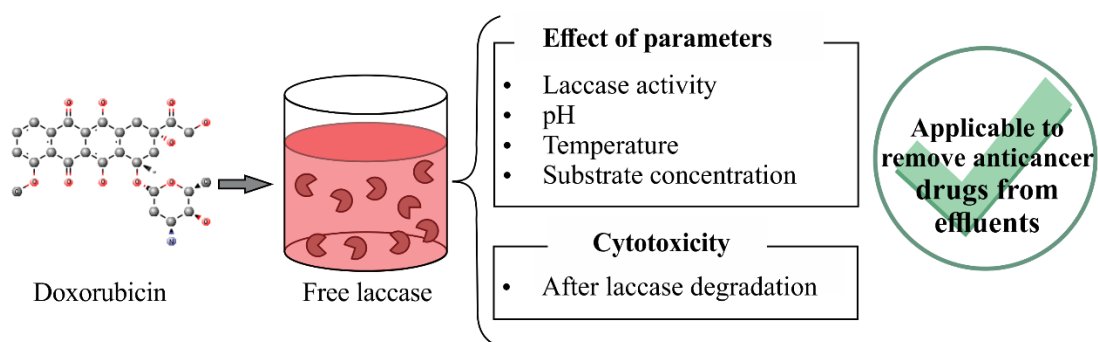

Source: From the author.

4.1 INTRODUCTION

In recent years a particular concern about the presence of emerging pollutants (EPs) in the environment as well in wastewater treatment plants (WWTPs) has been growing (DEBLONDE; COSSU-LEGUILLE; HARTEMANN, 2011; GOGOI *et al.*, 2018). Some EPs, as pharmaceutical products (PPs), are taken by patients, then eliminated by feces and urine and discharge in WWTPs (BILAL *et al.*, 2019; STARLING; AMORIM; LEÃO, 2018). However, the WWTPs were not designed to remove these compounds (TEODOSIU *et al.*, 2018). Several PPs were not altogether removed and pass, unaltered, or in metabolite forms, to the environment (RODRIGUEZ-NARVAEZ *et al.*, 2017).

PPs are biologically active substances and may influence the environment negatively, as well as cause human health problems (LÓPEZ-SERNA; PETROVIĆ; BARCELÓ, 2012). Anticancer drugs are one example, once they present cytotoxic, mutagenic, teratogenic, and carcinogenic effects, even in low concentration (NEGREIRA *et al.*, 2013; SANTANA-VIERA *et al.*, 2019). There are several anticancer drugs, which present different action mechanisms, as antimetabolites, alkylating of DNA, cross-linking of DNA, intercalating agents, topoisomerase inhibitor, and DNA-cleaving agents (NUSSBAUMER *et al.*, 2011). These action mechanisms variety make most worrying about releasing them in the environment.

Anticancer drugs have already been detected in hospital wastewater, as well as in surface water samples. Doxorubicin, etoposide, fluorouracil, cyclophosphamide, ifosfamide, tamoxifen, vinblastine, vincristine are examples of anticancer drugs detected around the world (KOSJEK *et al.*, 2013; MAHNIK *et al.*, 2007; NEGREIRA; DE ALDA; BARCELÓ, 2014; SANTANA-VIERA *et al.*, 2019; YIN *et al.*, 2010).

Doxorubicin (DOX) is a widely used anticancer drug for the treatment of several types of cancers (CAPELÔA *et al.*, 2020). It can be eliminated by urine (3-10%) and feces (40-50%) (GÓMEZ-CANELA *et al.*, 2014). DOX has environmental concern because it can be detected in oncologic hospital wastewater at the concentration range of 0.26-1.35 $\mu\text{g}\cdot\text{L}^{-1}$ (MAHNIK *et al.*, 2007), as well in WWTPs effluent at a concentration of 0.02 - 0.042 $\mu\text{g}\cdot\text{L}^{-1}$ (MARTÍN *et al.*, 2014). Besides, eco-genotoxicity studies showed that doxorubicin causes DNA damage to *Ceriodaphnia dubia* cells at a concentration of 0.05 $\mu\text{g}\cdot\text{L}^{-1}$ (LAVORGNA *et al.*, 2015). Due to the potential risks, DOX is also one of the substances included in the list of emerging substances made by NORMAN (Network of reference laboratories, research centers and related organizations for monitoring of emerging environmental substances) (NORMAN, 2016).

In this sense, the development of alternative or improvement of current processes is needed, aiming at the degradation of anticancer drugs in hospital wastewater. Studies to remove EPs using advanced oxidation processes (e.g., photo-phantom, ozonization), phase-changing technologies (e.g., adsorption using activated carbon and membrane technology) and biological processes (e.g., activated sludge, biological filtration, and fungal removal) have been developed (MIR-TUTUSAUS *et al.*, 2017; RODRIGUEZ-NARVAEZ *et al.*, 2017). Fungal processes are reported to have the capability to remove anticancer drugs (CASTELLET-ROVIRA *et al.*, 2018; FERRANDO-CLIMENT *et al.*, 2015; HAROUNE *et al.*, 2014). The complete removal of azathioprine, etoposide and tamoxifen was achieved using white-rot fungi to treat wastewater from a hospital (FERRANDO-CLIMENT *et al.*, 2015). For cyclophosphamide and ifosfamide, the maximum removal was ranging from 40 to 61% (CASTELLET-ROVIRA *et al.*, 2018; FERRANDO-CLIMENT *et al.*, 2015). These studies indicate that the removal of anticancer drugs can be attributed to enzymatic degradation (CASTELLET-ROVIRA *et al.*, 2018; FERRANDO-CLIMENT *et al.*, 2015; HAROUNE *et al.*, 2014). In this sense, another alternative is the direct application of enzymes to remove these pollutants.

Enzymatic processes have many advantages compared with physical-chemical and biological ones. They are safer processes (once enzymes are considered eco-friendly catalysis processes), produce a lower amount of sludge, require lower energy, do not require nutrients addition, the by-products generated are non-toxic, and can be used in wastewaters having a very low concentration of pollutants (KAUSHAL *et al.*, 2018; MORSI *et al.*, 2020; PEREIRA *et al.*, 2020). Previous studies have shown that enzymes are efficient in removing PPs, endocrine disruptors, dyes, and other hazardous compounds (BILAL *et al.*, 2019; IARK *et al.*, 2019; LLORET *et al.*, 2010; NAGHDI *et al.*, 2018b; VARGA *et al.*, 2019). Two recent review papers were published indicating the potential of oxidoreductases, as lignin peroxidase, manganese peroxidase, versatile peroxidase, and laccase for degradation of anticancer drugs (PEREIRA *et al.*, 2020; YADAV *et al.*, 2020). Peroxidases use hydrogen peroxide as a natural co-substrate (requiring a supply of H₂O₂ during the reaction), besides that in excess of H₂O₂ or lack of reducing co-substrates, peroxidases are usually deactivated. Laccase (LC) uses molecular oxygen as co-substrate for catalysis and produces water as a by-product, needing just to maintain the dissolved oxygen enough to the reaction occurs (CHEA *et al.*, 2012; DARONCH *et al.*, 2020; UNUOFIN; OKOH; NWODO, 2019). LC also presents a low substrate specificity (being able to catalyze several reactions) (BARRIOS-ESTRADA *et al.*, 2018), availability and

low price (ZDARTA *et al.*, 2020), showing industrial and environmental advantages for its application as a catalyst for the degradation of hazardous compounds.

Laccase (EC 1.10.3.2) is an oxidoreductase enzyme that belongs to a multi-copper oxidase (GIARDINA *et al.*, 2010). LC has preference by phenolic compound, but due to the non-specificity by the substrate, are also able to degrade aromatic amines and related substances, thiol groups, diamines, N-heterocycles, phenothiazines, etc. (ALCALDE, 2007; RIVERA-HOYOS *et al.*, 2013). Fungal LCs are well known for degrading efficiently PPs as antibiotics, anti-inflammatories, antiepileptics, and hormones (MORSI *et al.*, 2020; VARGA *et al.*, 2019). For example, LC (concentration $\geq 250 \text{ U}\cdot\text{L}^{-1}$) from *Trametes versicolor* was able to remove the antibiotic tetracycline completely in pH 5 after 30 min at 25 °C (ZDARTA *et al.*, 2020). Immobilized LC from *Trametes versicolor*, in the activity of $60 \text{ U}\cdot\text{L}^{-1}$, was capable of removing 95% of carbamazepine (antiepileptic) in a mediator system at 35 °C and pH 6 after 24h (NAGHDI *et al.*, 2018b). After 8h at room temperature, the degradation of the hormones estrogen, estradiol and ethinylestradiol reached values ranging from 60 to 95% (in pHs 4, 5 and 7) using LC from *Myceliophthora thermophila*, activity of $2000 \text{ U}\cdot\text{L}^{-1}$. Diclofenac (inflammatory), in the same conditions, reached a maximum removal of 65% in pH 4 (LLORET *et al.*, 2010). However, there is a lack of studies of anticancer drugs removal, especially doxorubicin, by fungal enzymes, aiming at environmental approaches.

To the best of our knowledge, there are just two studies, which used free enzymes for the degradation of anticancer drugs. Exogenous NADH (nicotinamide adenine dinucleotide) dehydrogenase was extracted from *Streptomyces* sp. and used to degrade DOX, achieving a K_M of $95 \pm 16 \mu\text{M}$ and V_{\max} of $2.06 \text{ mmol}\cdot\text{s}^{-1}$. The authors suggest an application for selective detoxification of drugs in non-cancerous tissues to help in the quality-of-life of chemotherapy patients (WESTMAN *et al.*, 2012). Another study describes the expression of the recombinant enzyme aldo-keto reductase (AKR1C3) from the human liver in *E. coli* strain. This work evaluated the DOX degradation by AKR1C3 to understand the development of resistance to anticancer drugs by humans, and the purpose was coadministration of AKR1C3 inhibitors in chemotherapeutic treatment. The kinetic parameters obtained were K_M of $355 \pm 36 \mu\text{M}$ and V_{\max} of $53 \pm 2 \text{ nmol}\cdot\text{min}^{-1}$ (NOVOTNA *et al.*, 2008). Although these papers are focused in the medical area, they support the hypothesis that enzymes can be used to degrade the anticancer drug doxorubicin.

In this sense, the main purposes of this study were to evaluate the potential of LC from *Trametes versicolor* to degrade doxorubicin in different conditions, determine the kinetics

degradation parameters, as well evaluate the environmental implications of DOX degradation products by *in vitro* study.

4.2 MATERIALS AND METHODS

4.2.1 Chemicals

Doxorubicin hydrochloride suitable for fluorescence ($\geq 98\%$), laccase from *Trametes versicolor* ($\geq 0.5 \text{ U}\cdot\text{mg}^{-1}$), and 3-ethylbenzthiazoline-6-sulfonic acid (ABTS $\geq 98\%$) were obtained from Sigma Aldrich Brazil. Citric acid ($\geq 98\%$) and dibasic sodium phosphate ($\geq 98\%$) were purchased from Neon (Brazil). Dulbecco's modified Eagle's medium (DMEM), Fetal Bovine Serum (FBS), sodium bicarbonate, penicillin/streptomycin, Phosphate Buffer Saline (PBS) are specific medium and reagents for cell culture and were obtained from Thermo Fisher Scientific. 3-(4,5-dimethylthiazol-2-yl)-5-(3-carboxymethoxyphenyl)-2-(4-sulfophenyl)-2H-tetrazolium (MTS) reagent was purchased from Promega. Ultrapure water was used in all experiments (Millipore simplicity system).

4.2.2 Laccase activity

The LC activity was determined before each experiment to standardize initial activities. The measurement was performed according to the manufacturer's instructions. Briefly, LC solution was prepared in a phosphate-citrate buffer (0.1M, pH 6) at a concentration of $1 \text{ mg}\cdot\text{L}^{-1}$. Then, 2.4 mL of phosphate-citrate buffer, 0.3 mL of ABTS (5 mM), and 0.3 mL of the LC solution were added in a quartz cuvette. The activity was measured at the temperature of 25 °C. The activity was calculated using Equation 3.

$$\frac{U}{L} = \frac{\Delta_{abs}\cdot V}{\varepsilon\cdot d\cdot v\cdot t} \quad \text{Equation 3}$$

One unit of laccase activity (expressed in $\text{U}\cdot\text{L}^{-1}$) is defined as the amount of enzyme necessary to catalyze 1 μmol of ABTS per min. Δ_{abs} is the variation of absorbance. V is the reactional volume (mL). ε is the molar extinction coefficient (for ABTS = $3.6\times 10^4 \text{ M}^{-1}\cdot\text{cm}^{-1}$). d is the cell path length (cm). v is the volume of the laccase solution (mL), and t is the reaction time (min).

4.2.2.1 Doxorubicin measurement

For all assays, DOX concentration was measured by fluorescence spectrophotometer (SpectraMax® Gemini™ EM, Molecular devices®). The excitation and emission wavelengths were 480 and 598 nm, respectively. One standard curve was determined for each pH to eliminate buffers interferences (See supplementary data Figure S5 and Figure S6). Assays were carried in 96-well black plates (Corning incorporated Costar®), with 200 μL of total volume reaction. The DOX degradation was measured in intervals of 30 min during 12 or 24 h. All experiments were performed in 6 replicates, except for assays to determine the Michaelis-Menten kinetic parameters, which were performed with 3 replicates.

4.2.2.2 Laccase-catalyzed degradation of doxorubicin

To evaluate the DOX degradation by LC, the influence of enzyme concentration, pH, and temperature were analyzed, and the kinetic parameters were obtained by Michaelis-Menten parameters, as described below.

4.2.2.2.1 Effect of laccase concentration on doxorubicin degradation

To evaluate the effect of LC activity on doxorubicin degradation, three LC concentrations (450, 900 and 1800 $\text{U}\cdot\text{L}^{-1}$) were used, based on studies of PPs degradation by LC (BARRIOS-ESTRADA *et al.*, 2018). In the literature, studies to degrade PPs usually use concentrations of these substances in the range of $\mu\text{g}\cdot\text{L}^{-1}$ (FERRANDO-CLIMENT *et al.*, 2015; NAGHDI *et al.*, 2018a; PEREIRA *et al.*, 2020). Thus, the DOX concentration was also varied (50, 250, and 500 $\mu\text{g}\cdot\text{L}^{-1}$) for each LC activity. The assays were carried in phosphate-citrate buffer (0.1 M) at pH 6 and temperature of 30 °C, which is the best enzymatic activity, according to manufacturing instructions. Control experiments were also performed without LC.

4.2.2.2.2 Effect of pH and temperature on doxorubicin degradation

The doxorubicin degradation in different pH values (ranging from 3 to 8) was performed in phosphate-citrate buffer (0.1 M) at 30 °C. To evaluate the effect of temperature, the pH was fixed with phosphate-citrate buffer (0.1 M) in the pH, which showed the higher degradation rate in the previous step, and the assays were conducted at temperatures of 20, 30, and 40 °C. All the experiments were performed with an LC concentration in the experiment described at 2.4.1.

4.2.2.2.3 Kinetic parameters of doxorubicin degradation

The initial degradation rates were obtained in all DOX degradation experiments, from the linear part of the plot, using the Equation 4.

$$v = - \frac{\partial S}{\partial t} \quad \text{Equation 4}$$

Where: v is the initial degradation rate ($\mu\text{g}_{\text{DOX}} \cdot \text{h}^{-1} \cdot \text{L}^{-1}$), ∂S is the variation of doxorubicin concentration ($\mu\text{g} \cdot \text{L}^{-1}$), ∂t is the variation in time (h). To obtain the specific initial degradation rate ($\mu\text{g}_{\text{DOX}} \cdot \text{U}^{-1} \cdot \text{h}^{-1}$), v was divided by the amount of enzyme ($\text{U} \cdot \text{L}^{-1}$).

In order to determine the maximal degradation rate (V_{max}) and Michaelis–Menten constant (K_{M}), the assays were carried out at the temperature of 30 °C and pH 7, in phosphate-citrate buffer (0.1 M), using doxorubicin concentrations ranging from 250 to 10000 $\mu\text{g} \cdot \text{L}^{-1}$. Degradation assay was performed by the addition of 900 $\text{U} \cdot \text{L}^{-1}$ of LC. To determine K_{M} and V_{max} , the Michaelis-Menten equation (Equation 5) was linearized by the Hanes-Woolf method (Equation 6).

$$v = \frac{v_{\text{max}} \cdot [S]}{K_{\text{M}} + [S]} \quad \text{Equation 5}$$

$$\frac{S}{v} = \frac{1}{v_{\text{max}}} \cdot S + \frac{K_{\text{M}}}{v_{\text{max}}} \quad \text{Equation 6}$$

4.2.2.3 Cytotoxicity assay

The murine fibroblast cell line (L-929) were cultured at 37 °C, under a humidified atmosphere, and 5% of CO₂, in DMEM medium supplemented with 10% FBS, 2.5 $\text{g} \cdot \text{L}^{-1}$ sodium bicarbonate, and 1% penicillin/streptomycin. In 96-well tissue culture plates, L-929 cells ($5 \cdot 10^3$ for well) were seeded and grown for 24 hours. After, cells were exposed to different concentrations (ranging from 62.5 to 1000 $\mu\text{g} \cdot \text{L}^{-1}$) of DOX and DOX degradation products (DOX-DP) for 24 hours. Control experiments were performed without the presence of DOX or DOX-DP. Cell viability assay was carried out by MTS assay according to the manufacturer's instructions. Briefly, the culture media were removed, and cells were washed with PBS. Then, 100 μL fresh medium and 20 μL of MTS reagent were added to each well; the 96-well tissue

culture plates containing cells were incubated at 37 °C for 2 h. After incubation, 100 µL each well was transferred to other 96-well plate and the absorbance was measured at a wavelength of 490 nm in a spectrophotometer (Spectramax® Paradigm, Molecular Devices®). The cell viability was calculated according to Equation 7.

$$\text{Cell viability(\%)} = \frac{\text{OD of treated cells}}{\text{OD of control cells}} \times 100 \quad \text{Equation 7}$$

All the experiments were performed in 4 replicates. Results were shown as mean ± SD, compared through the analysis of variance one-way (ANOVA) and Tukey test. Statistical significance values were considered when $p < 0.05$.

4.3 RESULTS AND DISCUSSION

4.3.1 Degradation of doxorubicin in different laccase concentration

LC from *Trametes versicolor* could degrade DOX from aqueous solution in all enzymatic activity and tested DOX concentrations (Figure 18). Concentrations in the magnitude of $\mu\text{g}\cdot\text{L}^{-1}$ are usually evaluated in studies of PPS degradation, once they can be found in this range, in wastewater samples (FERRANDO-CLIMENT *et al.*, 2015; NAGHDI *et al.*, 2018a; PEREIRA *et al.*, 2020; STARLING; AMORIM; LEÃO, 2018). In the first step, three different DOX concentrations (50, 250 and 500 $\mu\text{g}\cdot\text{mL}^{-1}$) were evaluated. LC was able to remove the anticancer drug even in lower tested concentration (50 $\mu\text{g}\cdot\text{mL}^{-1}$), which could be a limitation for future applications. The concentrations of 250 and 500 $\mu\text{g}\cdot\text{L}^{-1}$ were also evaluated to a precise obtaining of kinetics parameters, once the quantification of DOX is more accurate.

Figure 18. Variation of laccase (LC) concentrations, where (■) without LC, (●) 450 U·L⁻¹, (▲) 900 U·L⁻¹ and (▼) 1800 U·L⁻¹, to degrade doxorubicin (DOX) at the concentrations of A) 50 μg·L⁻¹, B) 250 μg·L⁻¹ and C) 500 μg·L⁻¹. All degradations were carried out at pH 6 and 30 °C.

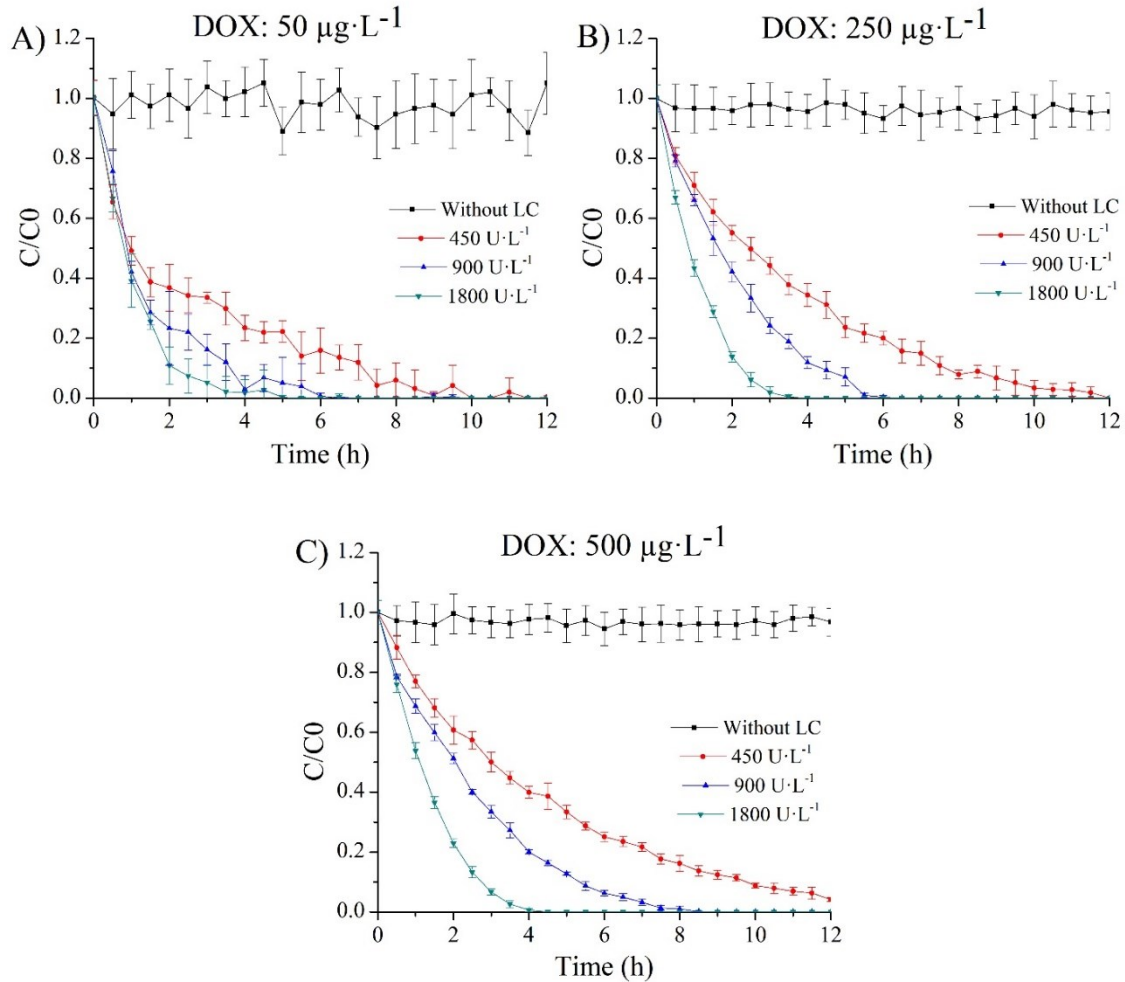

The results showed an inversely proportional relationship between the variables studied (LC and time). As expected (Figure 18), when the enzymatic activity was increased, DOX degradation time was shorter. According to Figure 18 A, B, and C, to the higher LC activity (1800 U·L⁻¹), DOX was completely degraded between 3 and 4 hours, regardless of the drug concentration. For the LC activity of 900 U·L⁻¹, the time to degrade DOX was ranging from 4 to 8 hours, while at the lowest LC activity tested (450 U·L⁻¹), DOX was degraded in 10, 12, and 16 hours (data not shown), for 50, 250 and 500 μg·L⁻¹, respectively. Concomitantly, control experiments without LC were carried out at pH 6 (citrate-phosphate buffer), where no degradation was observed.

The specific initial degradation rates were calculated and it is shown in Table 6. Between the enzymatic concentration of 450 and 900 U·L⁻¹, there is no difference in the specific initial degradation rate. However, the specific initial degradation rate decreased 50, 29, and 16% to 50, 250, and 500 µg·L⁻¹ of DOX, respectively, when a larger concentration of LC was used (1800 U·L⁻¹).

Table 6. Comparison between the specific initial degradation rates of the laccase (450, 900, and 1800 U·L⁻¹) to degrade doxorubicin at concentrations of 50, 250, and 500 µg·L⁻¹

Doxorubicin concentration (µg·L ⁻¹)	Initial specific degradation rate µg _{DOX} ·(U·h) ⁻¹		
	450 U·L ⁻¹	900 U·L ⁻¹	1800 U·L ⁻¹
50	0.02 ± 0.006	0.02 ± 0.007	0.01 ± 0.002
250	0.07 ± 0.005	0.070 ± 0.007	0.05 ± 0.002
500	0.13 ± 0.007	0.12 ± 0.005	0.10 ± 0.004

The relationship between a decrease of specific initial degradation rate and DOX concentration was inversely proportional. The lower DOX concentration used (50 µg·L⁻¹) showed a bigger decrease in the specific initial degradation rate (50%), indicating that in lower DOX concentrations is not necessary to use high amounts of LC. The lowest specific initial degradation rate, when 1800 U·L⁻¹ of LC was used, can be attributed to a high amount of enzyme in relation to the substrate concentration. The amount of enzyme is one of the key points when we are thinking of wastewater treatment application since the costs have to be minimized for this technology to become a reality. Further experiments were performed with the enzymatic concentration of 900 U·L⁻¹ and the DOX concentration of 250 µg·L⁻¹, which enabled obtaining data to the determination of kinetic parameters.

4.3.2 Evaluation of optimal pH to doxorubicin degradation

The DOX degradation by LC presented a dependence on pH (Figure 19). LC was not able to degrade DOX at pH 3. By increasing the pH to 4 the drug started to be degraded, and, as the pH increased, the degradation also increased until the pH reaches neutrality (pH 7). At pH 7 DOX was degraded after 2 hours.

Figure 19. Degradation of doxorubicin by laccase at different pH values. Degradations were carried out at 30 °C, with 250 $\mu\text{g}\cdot\text{L}^{-1}$ of DOX, and 900 $\text{U}\cdot\text{L}^{-1}$ of LC.

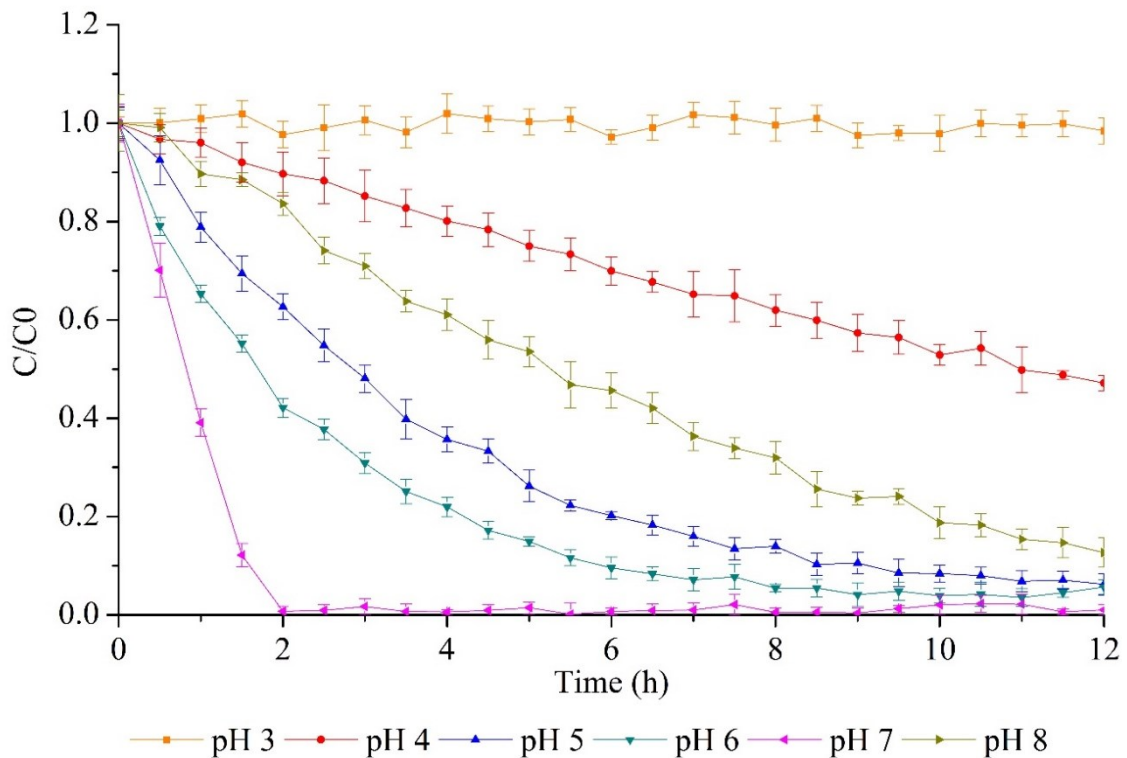

Meantime, for the experiment performed at pH 8 the degradation rate decreased, and even after 12 hours, DOX was not completely degraded, corroborating with the initial specific degradation rate values obtained (Table 7).

Table 7. Comparison of the initial specific degradation rates to degrade doxorubicin at different pH values.

pH	Initial specific degradation rate
	$\mu\text{g}_{\text{DOX}}\cdot(\text{U}\cdot\text{h})^{-1}$
3	0.0007 ± 0.0002
4	0.015 ± 0.0004
5	0.047 ± 0.0009
6	0.066 ± 0.003
7	0.148 ± 0.007
8	0.031 ± 0.003

The degradation rate increased when pH was gradually increased, until the maximum value of $0.149 \mu\text{g}_{\text{DOX}} \cdot \text{h}^{-1} \cdot \text{U}^{-1}$ at pH 7. After (pH 8), the degradation rate decreased due to the low LC activity in basic pH values (LLORET *et al.*, 2010). There is an inhibition of enzymatic activity generated by the presence of hydroxide anion (basic pH), which interrupts the internal electron transfer from Type-1 to Type-2/Type-3 copper in laccase, due to the attachment of hydroxide anion in the Type-2/Type-3 coppers (XU, 1997). The degradation by LC is also dependent on the redox potential difference between the substrate and the T1 copper center, and when the pH is increased, the potential redox decreases (XU, 1996). This fact justifies the decrease of 79% in the initial specific degradation rate when the pH was changed from 7 to 8.

The measurement of LC activity is performed on standard substrates, as ABTS, guaiacol, and syringaldazine (UNUOFIN; OKOH; NWODO, 2019). For these substrates, the best activities are related to acidic pH values, ranging from 3 to 6 (LLORET *et al.*, 2010; MAJEAU; BRAR; TYAGI, 2010). However, the relationship between the optimal pH and enzymatic activity is also dependent on the substrate (MOGHARABI; FARAMARZI, 2014; NAGHDI *et al.*, 2018a). A previous study reported that DOX has high stability at acidic pH values (pH 4), and as the pH increase, the molecule loses stability (BEIJNEN *et al.*, 1986). Although DOX does not present good stability at basic pH, in the present work, the drug degradation at all pH values can be attributed to the enzymatic catalysis. Control tests were performed (drug without the presence of LC), and DOX degradation was not observed during the experiment period (Figure S7). The highest specific degradation rate in pH 7 might be related to the two factors presented above, the low LC activity in basic pH and the low DOX stability in basic pH values. Lastly, conventional wastewater treatment plants typically operate at pH close to neutrality, and the results of pH 7 as the optimal pH value for DOX degradation can be considered promising.

4.3.3 Evaluation of different temperatures over doxorubicin degradation

The temperature was an important factor in DOX degradation, as can be seen in Figure 20. The temperatures of 30 and 40 °C showed complete degradation of DOX at 2 and 2.5 hours, respectively. Even in the lower temperature tested (20 °C). LC was able to degrade DOX completely in 8.5 hours.

Figure 20. Degradation of doxorubicin by laccase at different temperatures. Degradations were carried out at pH 7 with $250 \mu\text{g}\cdot\text{L}^{-1}$ of DOX and $900 \text{ U}\cdot\text{L}^{-1}$ of LC.

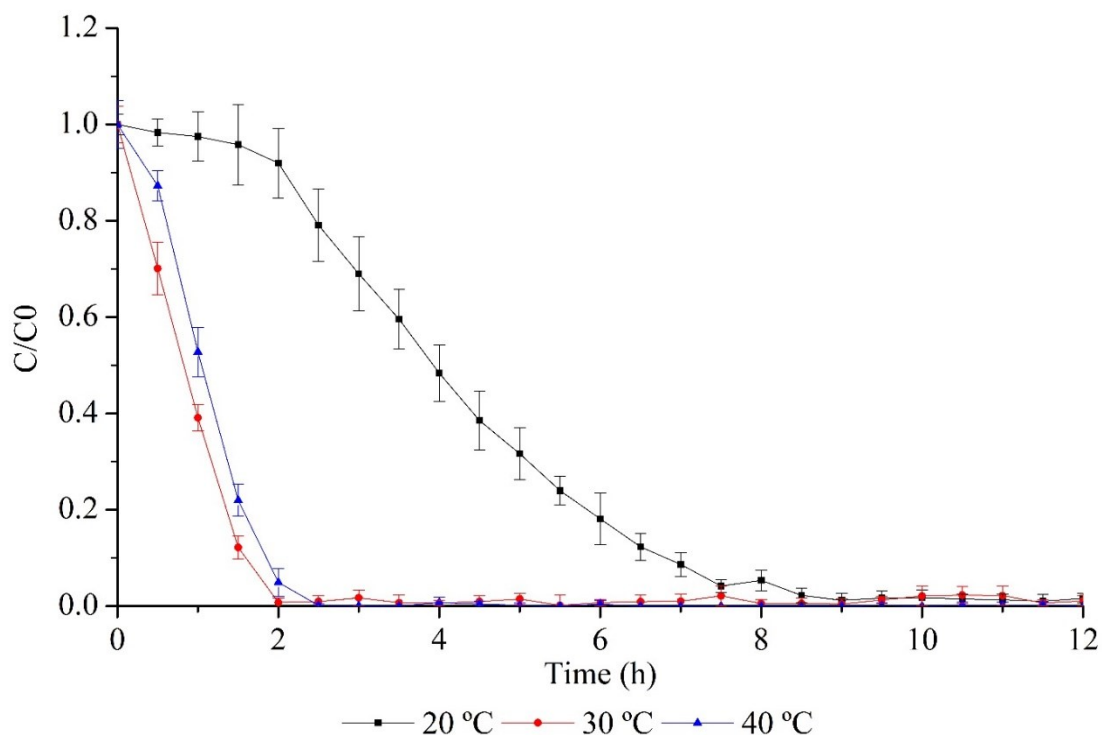

The initial specific rate for the degradation of DOX is shown in Table 8. At 20 °C, the degradation rate was 68.5% and 71.5% lower when compared to experiments performed in the temperatures of 30 and 40 °C, respectively.

Table 8. Comparison of the initial specific degradation rates to degrade doxorubicin at different temperatures.

Temperature (°C)	Initial specific degradation rate $\mu\text{g}_{\text{DOX}}\cdot(\text{U}\cdot\text{h})^{-1}$
20	0.047 ± 0.003
30	0.149 ± 0.007
40	0.165 ± 0.005

However, the degradation rate value for 40 °C is just 9.7% higher than when performed at 30 °C, which cannot justify the use of higher temperature (40 °C). Temperatures between 25 to 35 °C are described as work temperatures to degrade emerging pollutants using LC, once are achieved a high percentage of degradation (BARRIOS-ESTRADA *et al.*, 2018). Lastly, degradation was assigned only to enzymatic catalysis, since DOX present good stability at all the temperatures tested (BEIJNEN *et al.*, 1986). In the supplementary data, Figure S8, the

controls without the presence of enzyme are shown, where no degradation of the drug was observed, corroborating with the literature (BEIJNEN *et al.*, 1986).

4.3.4 Determination of Michaelis-Menten kinetic parameters

The assay was carried out in different concentrations of DOX for better comprehension of this substrate degradation by LC and obtaining of the kinetic parameters of the reaction. The relationship between the degradation rate and DOX concentration followed the Michaelis-Menten model (Figure 21), whose equation describes a first-order reaction widely used to describe enzymatic catalysis behavior.

Figure 21. Relationship between initial degradation rates and doxorubicin concentration to determine the kinetic parameters. All degradations were carried out at 30 °C, pH 7 and 900 U·L⁻¹ of laccase.

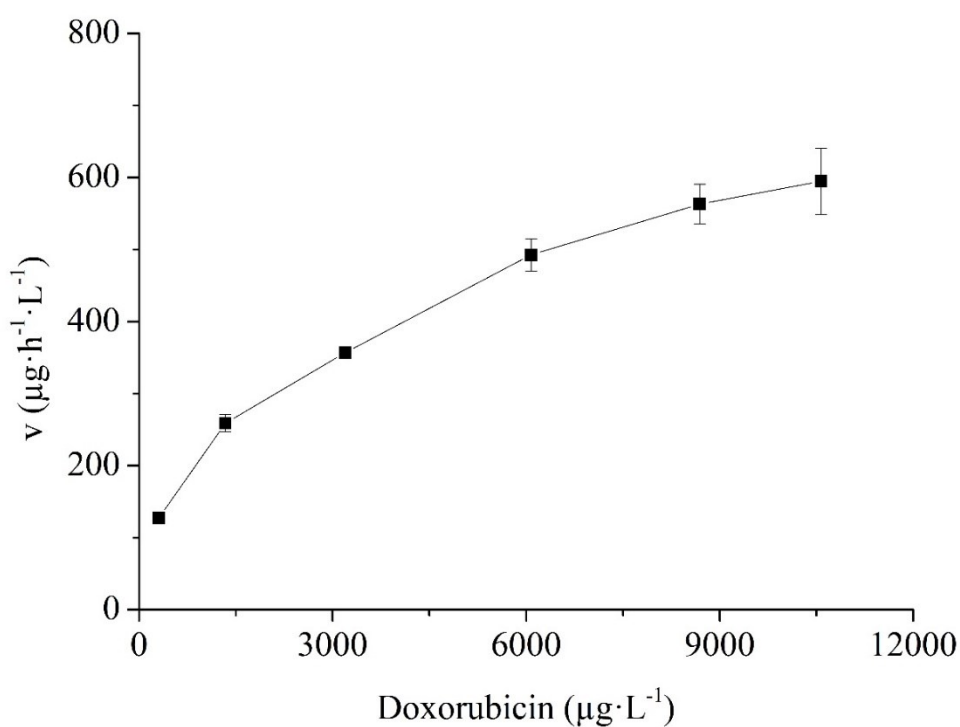

The control experiments showed no signs of degradation (supplementary data Figure S9). To investigate the parameters of DOX degradation by LC, a kinetic model was fitted to the experimental data using Hanes-Woolf linearization (plot not shown), which presented fitted plots with r^2 of 0.98. The obtained V_{\max} value was $702.8 \pm 72.8 \mu\text{g}_{\text{DOX}} \cdot \text{h}^{-1} \cdot \text{L}^{-1}$, while the K_M value was $2204.3 \pm 394.9 \mu\text{g}_{\text{DOX}} \cdot \text{L}^{-1}$ ($4.05 \pm 0.72 \mu\text{M}$). V_{\max} describes when all the active sites in the enzyme solution are filled by the substrate, and the Michaelis-Menten constant K_M

represents a direct relationship of the formation and disappearing of the enzyme-substrate complex, indicating the affinity of the enzyme-substrate.

To the best of our knowledge, there are only two studies using free enzymes for DOX degradation. The NADH dehydrogenase from *Streptomyces* sp was used to perform DOX degradation in the presence of NADH as a cofactor, and the kinetic parameter of K_M obtained was $95 \pm 16 \mu\text{M}$ (WESTMAN *et al.*, 2012). The recombinant aldo-keto reductase (AKR1C3) from human liver was expressed in *E. coli* strain, and the extracted enzyme shows the K_M value of $355 \pm 36 \mu\text{M}$ (NOVOTNA *et al.*, 2008). Once K_M value gives information about the affinity with the substrate, when compared with NADH dehydrogenase and aldo-keto reductase, LC presents a better affinity with DOX (lower K_M value). LCs are already described for having affinity with several substrates, among them hazardous contaminants (IARK *et al.*, 2019; NAGHDI *et al.*, 2018b; RAHMANI *et al.*, 2015). Thus, we can conclude that LC is a promising enzyme for the degradation of anticancer drugs.

4.3.5 Toxicity of LC degraded metabolites

Eco-genotoxicity tests of DOX in *Ceriodaphnia dubia* cells showed environmental risk, even in concentrations such as $0.05 \mu\text{g}\cdot\text{L}^{-1}$ (LAVORGNA *et al.*, 2015). To investigate the toxicity after degradation, *in vitro* cell viability tests were performed on a standard cell line (L-929). The comparison of the exposure results is shown in Figure 22.

Figure 22. Cell viability of L-929 cells after 24 hours of exposure to doxorubicin (DOX) and doxorubicin degradation products (DOX-DP) by laccase. Indicated points on the graph by (*) are values statistically significant ($p < 0.05$) related to the control.

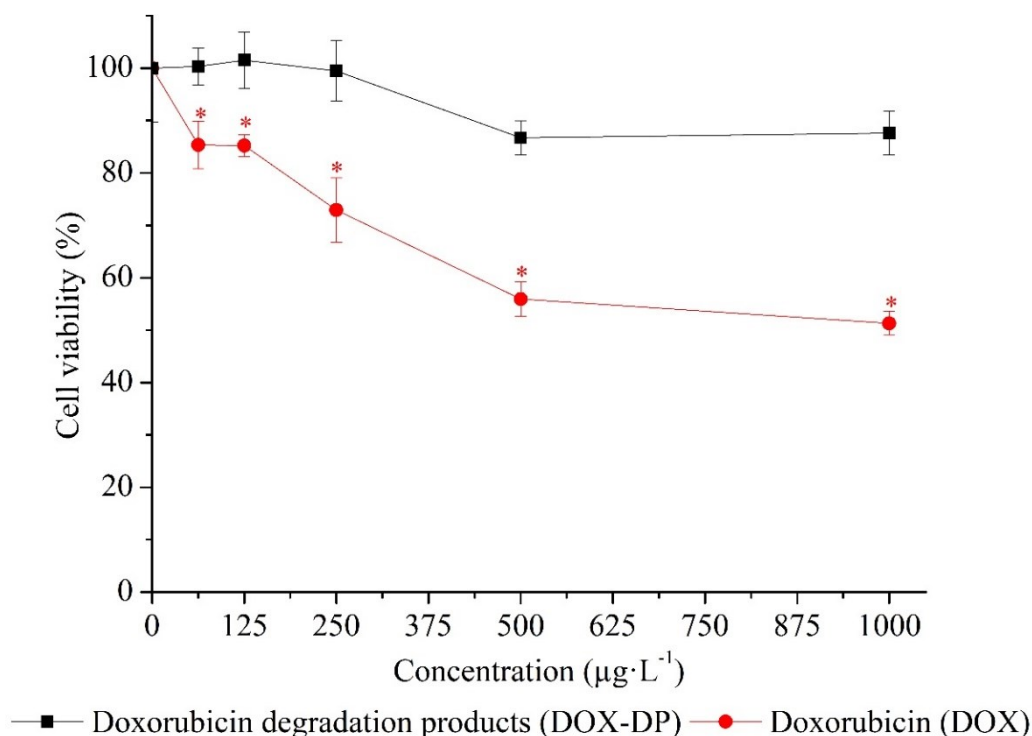

The DOX-DP showed no significant changes in L-929 cell viability ($p < 0.05$, relative to the control). Even in the highest tested concentrations, the cell viability was $86.7 \pm 3.2\%$, for $500 \mu\text{g}\cdot\text{L}^{-1}$, and $87.6 \pm 4.1\%$ for $1000 \mu\text{g}\cdot\text{L}^{-1}$. Meantime, all DOX concentrations showed a significant reduction in cell viability. In the lowest tested concentration, $62.5 \mu\text{g}\cdot\text{L}^{-1}$, the cell viability was $85.3 \pm 4.5\%$. When the DOX concentration was increased to 250 and $1000 \mu\text{g}\cdot\text{L}^{-1}$, the cell viability decreased to $72.9 \pm 3.2\%$ and $51.3 \pm 2.6\%$, respectively — clearly showing that LC is capable of reducing the toxicity of DOX.

Kadu *et al.* (2017) analyzed the cytotoxicity of DOX and DOX-DP by iron-nickel bimetallic nanoparticles, which mimics the active site of aldo-keto reductase enzyme. They found similar results to the present work. They observed that even in $50 \mu\text{g}\cdot\text{L}^{-1}$, DOX showed a decrease in cell viability of the human embryonic kidney (HEK293) cell line, while the DOX-DP by the bimetallic nanoparticles showed no significant reduction in cell viability until the concentration of $800 \mu\text{g}\cdot\text{L}^{-1}$ (approximately 90% of the cell viability) (KADU *et al.*, 2017).

LC has been reported to be able to degrade EPs (such as herbicides, dyes, PPs, among others) with high removal percentages, and also reducing the toxicity of its original compound (BILAL *et al.*, 2019; OSMA; TOCA-HERRERA; RODRÍGUEZ-COUTO, 2010; PALVANNAN *et al.*, 2014; RAHMANI *et al.*, 2015). The antibiotics tetracycline and

ampicillin were completely degraded by LC, and the degradation products showed a reduction of 10-times in the antimicrobial activity tests in *E. coli* and *Bacillus subtilis* (ZHANG *et al.*, 2020). The endocrine disruptor chemicals nonylphenol and octylphenol, after LC degradation did not show any estrogenic activity (CATAPANE *et al.*, 2013), while, the degradation of azo dye Congo red by LC showed a reduction of the toxicity of 92.5% using the Microtox assay (IARK *et al.*, 2019)

Lastly, the toxicity reduction associated with higher degradation percentage makes the LC use promising, not only for the removal of DOX but also for other antineoplastic drugs since LC can oxidize a wide variety of substances (BARRIOS-ESTRADA *et al.*, 2018; GIARDINA *et al.*, 2010).

4.3.6 Laccase applicability and future trends to remove anticancer drugs from effluents

The temperature and pH in which LC reaches the high specific degradation rate was 30 °C and 7, respectively. Furthermore, the LC concentration did not affect the specific degradation rate, indicating that with low enzyme concentration, the drug can be degraded successfully. The obtained kinetic parameter value of K_M of $4.05 \pm 0.72 \mu\text{M}$ also indicates a good affinity with the substrate. These results show great potential to the application of LC to remove anticancer drugs in effluents from oncological wastewater treatment plants. The operational conditions in which LC successfully degraded DOX were similar to working operational conditions found in wastewater treatment plants (MIR-TUTUSAUS; SARRÀ; CAMINAL, 2016).

Moreover, LC has been known to generate degradation products less toxic than the original pollutant (MAJEAU; BRAR; TYAGI, 2010). The results obtained in this work corroborate with this affirmation. The reduction of the toxicity is a critical factor when we are thinking about the presence of anticancer drugs in the effluents. Once even in low concentrations, they show a risk to the environment and human health (YADAV *et al.*, 2020). Another important factor to be considered in future works will be the identification of the degradation products to confirm the reduction of toxicity.

Lastly, the concern about the presence of PPs in water has been growing in the last years (STARLING; AMORIM; LEÃO, 2018; TAHERAN *et al.*, 2018). There is a tendency to strict the regulations about it (TEODOSIU *et al.*, 2018). In this sense, the development of applicable technologies is critical. Studies have described the laccases as a promising catalyst

to remove PPs from effluents. The enzymes can be used free or also immobilized in WWTP (enabling recycle of the enzymes) (DARONCH *et al.*, 2020), which permit the application of several configurations of reactors and act as a polishing treatment.

4.4 PARTIAL CONCLUSIONS

The degradation of the anticancer drugs by enzymes (in especial LC) was here described for the first time, focusing on application to remove these drugs from effluents. As hypothesized, the present work demonstrated that LC degrades DOX at all concentrations tested. The LC concentration was inversely proportional to degradation time. However, the specific initial degradation rate decreased when the concentration of LC was increased from 900 to 1800 U·L⁻¹, which indicates that it is not necessary to add a great amount of enzyme to catalyze the reaction. The optimum conditions for the DOX degradation (pH and temperature) were similar to those found in effluent from WWTPs, which makes it interesting to remove this EP from hospitals or pharmaceutical industries wastewaters. It is important to emphasize that DOX-DP showed less cytotoxicity when compared to DOX, as a consequence of LC catalysis. In conclusion, LC could be effectively used in a novel strategy to remove anticancer drugs from effluents, and the studies using other anticancer drugs are necessary to provide information about the LC capability to degrade them.



Final contextualization and other activities

In this chapter, it is presented the contextualization regarding the application of the two studies problems and also other academic activities developed during the doctorate.

5 FINAL CONTEXTUALIZATION AND OTHER ACTIVITIES

5.1 FINAL ASPECTS, RELEVANCE AND APPLICABILITY

Herein, I expatiate on my personal point of view about the subjects studied in the thesis and their applicability are described hereafter.

5.1.1 Final aspects and importance of studying the influence of anticancer drugs on the anaerobic digestion microbial community

Anaerobic digestion fits in the context of the study done in Chapter 3 in two main aspects. First, some anaerobic reactors such as AnMBR (anaerobic membrane bioreactor) and UASB (Upflow Anaerobic Sludge Blanket reactor) can be used for decentralized wastewater treatment. Hospitals are important candidates where to decentralized WWTPs, removing organic pollutants and PPs. Thus, it is crucial to understand the effect of these drugs on the process.

Secondly, in the case of aerobic processes being used to treat the effluent from a hospital, the waste activated sludge can be stabilized by a digester. According to the results found in Chapter 3 and several other studies in the literature, some drugs can be sorbed by the sludge. For example, the biomass might sorb the anticancer drugs and increase their concentration in the waste activated sludge, causing a negative effect and the microbial community from the digester (anaerobic digestion process).

5.1.2 Application of enzymatic processes in the wastewater treatment

Enzymes have been shown to have great potential to be applied in WWTPs (ABEJÓN *et al.*, 2015). Studies have described LC as a promising biocatalyst to remove PPs from effluents. As discussed in Chapter 4, LC can remove anticancer drugs efficiently. However, enzyme reuse is essential to be an applicable approach to real wastewater treatment plants. In this sense, the development of new technologies is crucial. LC can be used free or immobilized, permitting their application on several configurations of reactors. Figure 23 shows the schematic representation of the enzymatic membrane reactors as a promising technology.

Figure 23. Representation of several enzymatic reactors using membranes to allow enzyme reuse.

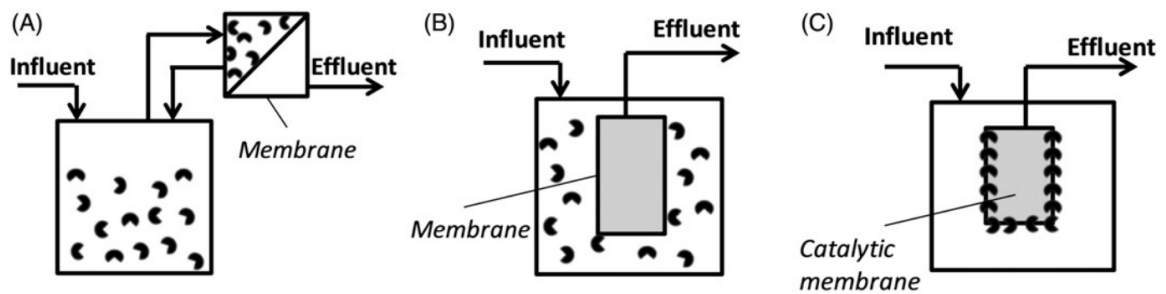

Source: From (ARCA-RAMOS *et al.*, 2018)

Figure 23 A shows that free enzymes can be used in a continuous stirred tank reactor coupled to an external membrane module, allowing the PPs degradation and further filtration. The membrane module can also be submerged in the tank reactor, as shown in Figure 23 B. Lastly, Figure 23 C demonstrates an enzymatic membrane reactor using the enzyme immobilized in the membrane, being a support for the biocatalyst. The enzymatic membrane reactors can be applied as a polishing treatment, according suggested in Figure 24.

Figure 24. A suggestion of applying enzymes as a polishing treatment using an enzymatic membrane reactor.

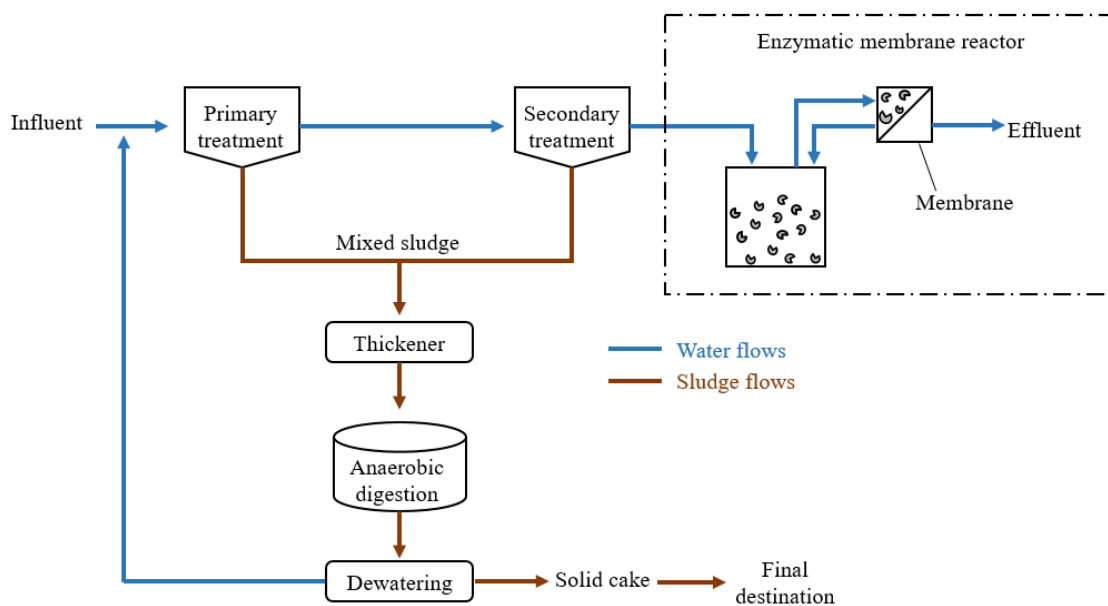

Source: From the author

The application of enzymes as a polishing treatment appears to be an interesting approach once the enzyme is not in contact with the sludge. Furthermore, after the secondary treatment, most nutrients are already removed, and the effluent composition might not present substances that can inhibit the enzymatic activity. The enzymatic process might remove the micropollutants, which are not removed by the biological processes.

5.2 RESEARCH PROJECT CARRIED OUT IN THE SANDWICH DOCTORATE

A sandwich period of 1-year and 1 month was done in the Netherlands. The activities were developed at Delft University of Technology (TU Delft) in the Department of Water Management, under the supervision of Professor Jules van Lier and Professor Merle de Kreuk. During this period, I developed a study regarding the fate of organic micropollutants after the thermal hydrolysis process (THP) in wastewater treatment plants.

The THP is a current technology used in WWTPs, as shown in Figure 25. The waste activated sludge is heated in temperatures ranging from 120 to 200 °C. Subsequently, the pretreated sludge is cooled and goes to the anaerobic digestion process. This process provides the solubilization of the organic matter of the waste activated sludge (from secondary treatment), which improves the biogas production and the dewaterability of the digestate. However, due to the presence of proteins (mostly from the biomass) and carbohydrates (released in the process) in the waste activated sludge, the Maillard reactions occur in the THP. This reaction generates melanoidins which have a wide range of molecular weight. Melanoidins are recalcitrant humic-like substances that show variability and complexity. They are difficult to characterize because the molecular structure and biological properties change according to the sugar and amino acid involved in the reaction (ARIMI *et al.*, 2014). These compounds can negatively impact the environment due to their recalcitrance if released without control (WILKIE; RIEDESEL; OWENS, 2000).

Figure 25. Plant-wide model of a WWTP using THP reactor.

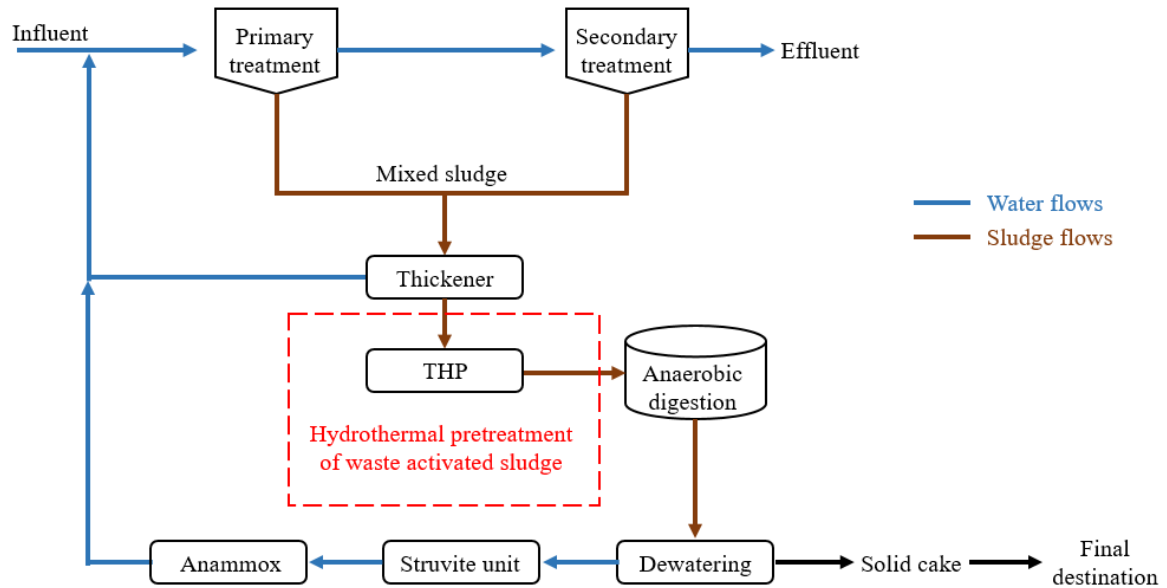

Source: From the author

In addition, the application of THP can also contribute to the PPs removal. However, studies about their fate in THP are scarce (TABOADA-SANTOS *et al.*, 2020). It is also suggested that PPs might be involved in the Maillard reactions, changing their properties. In low working temperatures, the THP does not significantly affect the removal of PPs and contribute to their solubilization (ZHANG and LI, 2018; CARBALLA *et al.*, 2006). However, when the temperature is increased to 160 °C, the removal of some PPs is $\geq 60\%$, and the antibiotic resistance genes are also removed. (TABOADA-SANTOS *et al.*, 2019).

In this sense, the goals of the sandwich doctorate were to i) understand the fate of organic micropollutants in THP operating in different temperatures as well as the rules of humic-like substances in the removal of these compounds; ii) evaluate the removal of these compounds in THP followed by anaerobic digestion and iii) evaluate the biotoxicity of humic-like substances generated by the Maillard Reaction in hydrothermal pretreatment of waste activated sludge in real effluent from full-scale WWTPs.

Lastly, the results obtained in this period have generated a research paper (under the writing and reviewing process). Furthermore, a technical report containing the results of the project it will also be sent to the Water Authorities from the Netherlands.

5.3 ASSESSMENT INDICATORS

This section list some evaluation indicators achieved during the doctoral period. Table 9 shows the undergraduate and master students and their respective projects I have supported during the doctoral period.

Table 9. Supporting done to undergraduate and master students during their academic formation.

Name/period	Project
Undergraduate research	
Adrielle Helena Mannrich (2018-2019)	Effect of etoposide on a mixed culture of methanogenic archaeas.
Lucas Pocrywiecki (2019-2020)	Effect of etoposide on a mixed and enriched culture of ammonia-oxidizing bacteria.
Master students	
Camila Senna Pereira (2018-2020)	Enzymatic process as a potential treatment technology to remove anticancer drugs from wastewater: Laccase-assisted degradation of etoposide.
Naionara Ariete Daronch Polyurethane (2018 -2020).	Polyurethane Foam as Matrix for One-Step Laccase Immobilization.
Bruna Savedra Santana (2021-2023).	Removal of anticancer drugs present in hospital effluents through the addition of zero-valent iron in anaerobic biological processes.

The participation in the projects work-team for the elaboration and execution of projects are described below:

- **Project:** Toxicity of emerging pollutants on bacteria from the biological aerobic and anaerobic treatment of effluent.

Manager: Prof. Camila Michels, P.h.D.

Period: 2018-2019

SIGPEX number: 201804811

- **Project:** Degradation of anticancer drugs by enzymatic processes
Manager: Prof. Hugo Moreira Soares, P.h.D
Period: 2019-2020
SIGPEX number: 201905017
- **Project:** Removal of anticancer drugs present in hospital effluents through the addition of zero-valent iron in anaerobic biological processes
Manager: Prof. Camila Michels, P.h.D
Period: 2021 - 2023
SIGPEX number: 202022602

The congresses and seminars that I have supported in the organization:

- 14th IWA Leading Edge Conference on Water and Wastewater Technologies (2017).
- 1st Seminar on Renewable Liquefied Fuel Gases (2021).

The review papers that I have supported in the conceptualization, writing and reviewing:

- “Potential of enzymatic process as an innovative technology to remove anticancer drugs in wastewater” (10.1007/s00253-019-10229-y) (PEREIRA *et al.*, 2020).
- “Elucidating the choice for a precise matrix for laccase immobilization: A review” (10.1016/j.cej.2020.125506) (DARONCH *et al.*, 2020).



Conclusion and suggestions for future studies

In this chapter, there are presented the conclusions and the suggestion to suggestions for future studies.

6 CONCLUSIONS AND SUGGESTIONS FOR FUTURE STUDIES

6.1 CONCLUSIONS

Additionally to the environmental risk, anticancer drugs can be harmful to the microbial community from WWTPs. Therefore, this study was divided into two main topics. First, chapter 3 corresponds to evaluating the effect of the anticancer drug DOX on acetoclastic methanogenesis (a limiting step in AD).

As hypothesized, DOX can also play a key role in inhibiting biological wastewater treatment processes. The short-term exposure of archaeas showed that DOX presents the potential to inhibit this group of microorganisms at concentrations $\geq 500 \mu\text{g}\cdot\text{L}^{-1}$, and the sorption into biomass might contribute to the inhibitory effect. Despite the low K_{ow} present by DOX, the sorption of the biomass might occur by electrostatic interactions. Furthermore, the archaeas can adapt to the inhibitory process and recovery after some time, suggesting that the inhibition mechanism is not related to microbial cell death. The main archaeas genus *Methanosaeta* and *Methanobacterium* were found in the biomass and *Mesotoga* genus was the most abundant bacteria. Moreover, as far as we went with the long-term experiment, it has shown the capability to recover the process after an adaptation period.

The second (chapter 4) is related to proposing a novel approach using enzymes to remove anticancer drugs, which might be recalcitrant to biological processes. LC was able to degrade DOX at all concentrations tested. The concentration of enzyme was inversely proportional to degradation time. However, the specific initial degradation rate decreased when the concentration of LC was increased from 900 to 1800 $\text{U}\cdot\text{L}^{-1}$, which indicates that it is not necessary to add a great amount of enzyme to catalyze the reaction. The optimum pH and temperature for the DOX degradation were similar to those found in effluent from WWTPs, making it interesting to remove this drug from hospitals or pharmaceutical industries wastewaters. It is important to emphasize that DOX-DP by LC showed less cytotoxicity when compared to DOX. LC could be effectively used in a novel strategy to remove anticancer drugs from effluents. To the best of our knowledge, we are researching novel directions on applying enzymes for the removal of anticancer drugs. However, additional studies using other anticancer drugs are necessary to provide more information about the degradation of them by LC.

6.2 SUGGESTIONS FOR FUTURE STUDIES

The suggestions for future studies are presented for each chapter according to shown below:

Suggestions for Chapter 3:

- Evaluate the influence of other anticancer drugs on methanogenesis.
- Evaluate the synergic effect of anticancer drugs on methanogenesis.
- Exposure of the methanogens archaeas to real wastewater from hospitals.
- Use state-of-art technologies approaches on anaerobic digestion to degrade anticancer drugs.

Suggestions for Chapter 4:

- Identify doxorubicin degradation products with LC-MS.
- Perform the degradation of other anticancer drugs by laccase.
- Evaluate the efficiency of laccase to remove anticancer drugs in real wastewater from hospitals.
- Immobilize the laccase on polymeric support and apply in an enzymatic reactor to remove anticancer drugs.

REFERENCES

- ABEJÓN, R. *et al.* Large-scale enzymatic membrane reactors for tetracycline degradation in WWTP effluents. **Water Research**, v. 73, p. 118–131, 2015.
- ALCALDE, M. Laccases: Biological functions, molecular structure and industrial applications. *In: Industrial Enzymes: Structure, Function and Applications*. Springer Netherlands, 2007. p. 461–476. *E-book*.
- ANDERSON, R. D. *et al.* Excision repair reduces doxorubicin-induced genotoxicity. **Mutation Research-DNA Repair**, v. 294, n. 3, p. 215–222, 1993.
- APHA. **Standard methods for the examination of water and wastewater**. 19. ed. Washington, DC: American Public Health Association, 2012. *E-book*.
- APPELS, L. *et al.* Principles and potential of the anaerobic digestion of waste-activated sludge. **Progress in Energy and Combustion Science**, v. 34, n. 6, p. 755–781, 2008.
- ARAÚJO, A. P. C. *et al.* Anti-cancer drugs in aquatic environment can cause cancer: Insight about mutagenicity in tadpoles. **Science of the Total Environment**, v. 650, p. 2284–2293, 2019.
- ARCA-RAMOS, A. *et al.* Enzymatic reactors for the removal of recalcitrant compounds in wastewater. **Biocatalysis and Biotransformation**, v. 36, n. 3, p. 195–215, 2018.
- ARIMI, M. M. *et al.* Antimicrobial colorants in molasses distillery wastewater and their removal technologies. **International Biodeterioration and Biodegradation**, v. 87, p. 34–43, 2014.
- AYDIN, S. *et al.* Inhibitory effects of antibiotic combinations on syntrophic bacteria, homoacetogens and methanogens. **Chemosphere**, v. 120, p. 515–520, 2015.
- BAI, X. *et al.* Occurrence, distribution, and seasonality of emerging contaminants in urban watersheds. **Chemosphere**, v. 200, p. 133–142, 2018.
- BAILEY, M. R. *et al.* Improved recovery of active recombinant laccase from maize seed. **Applied Microbiology and Biotechnology**, v. 63, n. 4, p. 390–397, 2004.
- BARRIOS-ESTRADA, C. *et al.* Emergent contaminants: Endocrine disruptors and their laccase-assisted degradation - A review. **Science of the Total Environment**, v. 612, p.

1516–1531, 2018.

BASSO, A.; SERBAN, S. Industrial applications of immobilized enzymes — A review. **Molecular Catalysis**, v. 479, p. 110607, 2019.

BEIJNEN, J. H. *et al.* Aspects of the degradation kinetics of doxorubicin in aqueous solution. **International Journal of Pharmaceutics**, v. 31, p. 75–82, 1986.

BESHA, A. T. *et al.* Removal of emerging micropollutants by activated sludge process and membrane bioreactors and the effects of micropollutants on membrane fouling: A review. **Journal of Environmental Chemical Engineering**, v. 5, n. 3, p. 2395–2414, 2017.

BESSE, J. P.; LATOUR, J. F.; GARRIC, J. Anticancer drugs in surface waters. What can we say about the occurrence and environmental significance of cytotoxic, cytostatic and endocrine therapy drugs? **Environment International**, v. 39, n. 1, p. 73–86, 2012.

BIAŁK-BIELIŃSKA, A. *et al.* Acute aquatic toxicity assessment of six anti-cancer drugs and one metabolite using biotest battery – Biological effects and stability under test conditions. **Chemosphere**, v. 189, p. 689–698, 2017.

BILAL, M. *et al.* Hazardous contaminants in the environment and their laccase-assisted degradation – A review. **Journal of Environmental Management**, v. 234, p. 253–264, 2019.

BOOKER, V. *et al.* Prioritising anticancer drugs for environmental monitoring and risk assessment purposes. **Science of the Total Environment**, v. 473–474, p. 159–170, 2014.

BRAY, F. *et al.* Global cancer transitions according to the Human Development Index (2008–2030): A population-based study. **The Lancet Oncology**, v. 13, n. 8, p. 790–801, 2012.

BRESSAN, C. R. **Toxicidade do antibiótico sulfato de colistina empregado na suinocultura sobre processos microbiológicos relacionados ao tratamento de efluentes.** 2012. (Doutorado) Programa de Pós- Graduação em Engenharia Química. Universidade Federal de Santa Catarina, Florianópolis-Brasil.

BUERGE, I. J. *et al.* Occurrence and fate of the cytostatic drugs cyclophosphamide and ifosfamide in wastewater and surface waters. **Environmental Science and Technology**, v. 40, n. 23, p. 7242–7250, 2006.

CACICEDO, M. L. *et al.* Self-assembly of carrageenin-CaCO₃ hybrid microparticles on bacterial cellulose films for doxorubicin sustained delivery. **Journal of Applied**

Biomedicine, v. 13, n. 3, p. 239–248, 2015.

CAPELÔA, T. *et al.* Metabolic and non-metabolic pathways that control cancer resistance to anthracyclines. **Seminars in Cell and Developmental Biology**, v. 98, p. 181–191, 2020.

CAPORASO, J. G. *et al.* Global patterns of 16S rRNA diversity at a depth of millions of sequences per sample. **Proceedings of the National Academy of Sciences of the United States of America**, v. 108, n. SUPPL. 1, p. 4516–4522, 2011. D

CASTELLET-ROVIRA, F. *et al.* *Stropharia rugosoannulata* and *Gymnopilus luteofolius*: Promising fungal species for pharmaceutical biodegradation in contaminated water. **Journal of Environmental Management**, v. 207, p. 396–404, 2018.

CATAPANE, M. *et al.* Enzymatic removal of estrogenic activity of nonylphenol and octylphenol aqueous solutions by immobilized laccase from *Trametes versicolor*. **Journal of Hazardous Materials**, v. 248–249, p. 337–346, 2013.

ČESEN, M. *et al.* Occurrence of cyclophosphamide and ifosfamide in aqueous environment and their removal by biological and abiotic wastewater treatment processes. **Science of the Total Environment**, v. 527–528, p. 465–473, 2015.

CETECIOGLU, Z. *et al.* Chronic impact of tetracycline on the biodegradation of an organic substrate mixture under anaerobic conditions. **Water Research**, v. 47, n. 9, p. 2959–2969, 2013.

CETECIOGLU, Z. *et al.* Acute inhibitory impact of antimicrobials on acetoclastic methanogenic activity. **Bioresource Technology**, v. 114, p. 109–116, 2012.

CHAKRABORTY, N.; SARKAR, G. M.; LAHIRI, S. C. Effect of pesticide (Tara-909) on biomethanation of sewage sludge and isolated methanogens. **Biomass and Bioenergy**, [S. l.], v. 23, n. 1, p. 75–80, 2002.

CHEA, V. *et al.* Optimization and characterization of an enzymatic membrane for the degradation of phenolic compounds. **Catalysis Today**, v. 193, n. 1, p. 49–56, 2012.

CHRISTOFF, A. P. *et al.* Bacterial identification through accurate library preparation and high-throughput sequencing [White Paper: Bacterial NGS Sequencing]. **Neoprosperta Microbiome Technologies**, n. May 2017, p. 5, 2017.

COETSIER, C. M. *et al.* Discharge of pharmaceutical products (PPs) through a conventional biological sewage treatment plant: MECs vs PECs? **Environment International**, v. 35, n. 5, p. 787–792, 2009.

CONAMA. Resolução n 430, 13 de maio de 2011. **Diário Oficial da União**, p. 8, 2011. Disponível em: <https://doi.org/10.1073/pnas.0703993104>

CREMONEZ, P. A. *et al.* Two-Stage anaerobic digestion in agroindustrial waste treatment: A review. **Journal of Environmental Management**, v. 281, p. 111854, 2021.

CRISCITIELLO, C. *et al.* Tamoxifen in early-stage estrogen receptorpositive breast cancer: Overview of clinical use and molecular biomarkers for patient selection. **OncoTargets and Therapy**, v. 4, p. 1–11, 2011.

CRUZ-MORATÓ, C. *et al.* Hospital wastewater treatment by fungal bioreactor: Removal efficiency for pharmaceuticals and endocrine disruptor compounds. **Science of the Total Environment**, v. 493, p. 365–376, 2014.

DARONCH, N. A. *et al.* Elucidating the choice for a precise matrix for laccase immobilization: a review. **Chemical Engineering Journal**, v. 397, p. 125506, 2020.

DEBLONDE, T.; COSSU-LEGUILLE, C.; HARTEMANN, P. Emerging pollutants in wastewater: A review of the literature. **International Journal of Hygiene and Environmental Health**, v. 214, n. 6, p. 442–448, 2011.

DELGADO, L. F. *et al.* Effect of cytostatic drugs on microbial behaviour in membrane bioreactor system. **Bioresource Technology**, v. 101, n. 2, p. 527–536, 2010.

DEMAIN, A. L.; SANCHEZ, Sergio. Microbial drug discovery: 80 Years of progress. **Journal of Antibiotics**, v. 62, n. 1, p. 5–16, 2009.

DIÁRIO OFICIAL DA UNIÃO. **PORTARIA GM/MS Nº 888, DE 4 DE MAIO DE 2021**. 2021. Available in: https://www.in.gov.br/en/web/dou/-/portaria-gm/ms-n-888-de-4-de-maio-de-2021-*-321540185.

DRUGBANK. **DrugBank Online | Database for Drug and Drug Target Info**. Available in: <https://go.drugbank.com/>.

EARLY BREAST CANCER TRIALISTS' COLLABORATIVE GROUP. Effects of chemotherapy and hormonal therapy for early breast cancer on recurrence and 15-year survival: an overview of the randomised trials. **The Lancet**, v. 365, 2005.

ESPINOSA-ORTIZ, E. J. *et al.* Fungal pelleted reactors in wastewater treatment: Applications and perspectives. **Chemical Engineering Journal**, v. 283, p. 553–571, 2016.

EUROPEAN COMMISSION. IMPLEMENTING DECISION (EU) 2018/840. **Official Journal of the European Union**, v. 61, n. L141/9, p. 9–12, 2018.

FÁBEROVÁ, M. *et al.* The influence of selected pharmaceuticals on biogas production from laboratory and real anaerobic sludge. **Environmental Science and Pollution Research**, 2019.

FERRANDO-CLIMENT, L. *et al.* Non conventional biological treatment based on *Trametes versicolor* for the elimination of recalcitrant anticancer drugs in hospital wastewater. **Chemosphere**, v. 136, p. 9–19, 2015.

FERRY, J. G. **Methanogenesis**. 1993. *E-book*. Available in: <https://doi.org/10.1007/978-1-4615-2391-8>

FLÓREZ, A. B. *et al.* Susceptibility of lactic acid bacteria, bifidobacteria and other bacteria of intestinal origin to chemotherapeutic agents. **International Journal of Antimicrobial Agents**, v. 48, n. 5, p. 547–550, 2016.

FOUNTOULAKIS, M. S.; STAMATELATOU, K.; LYBERATOS, G. The effect of pharmaceuticals on the kinetics of methanogenesis and acetogenesis. **Bioresource Technology**, v. 99, n. 15, p. 7083–7090, 2008.

FRANQUET-GRIELL, H. *et al.* Predicting concentrations of cytostatic drugs in sewage effluents and surface waters of Catalonia (NE Spain). **Environmental Research**, v. 138, p. 161–172, 2015.

FRANQUET-GRIELL, H. *et al.* Biological and photochemical degradation of cytostatic drugs under laboratory conditions. **Journal of Hazardous Materials**, v. 323, p. 319–328, 2017.

GHASIMI, D. S. M. *et al.* Impact of lignocellulosic-waste intermediates on hydrolysis and methanogenesis under thermophilic and mesophilic conditions. **Chemical Engineering Journal**, v. 295, p. 181–191, 2016.

GHATTAS, A. K. *et al.* Anaerobic biodegradation of (emerging) organic contaminants in the aquatic environment. **Water Research**, v. 116, p. 268–295, 2017.

GIARDINA, P. *et al.* Laccases: A never-ending story. **Cellular and Molecular Life Sciences**, v. 67, p. 369–385, 2010.

GOGOI, A. *et al.* Occurrence and fate of emerging contaminants in water environment: A review. **Groundwater for Sustainable Development**, v. 6, p. 169–180, 2018.

GÓMEZ-CANELA, C. *et al.* Occurrence of cytostatic compounds in hospital effluents and wastewaters, determined by liquid chromatography coupled to high-resolution mass spectrometry. **Analytical and Bioanalytical Chemistry**, v. 406, p. 3801–3814, 2014.

GRENNI, P.; ANCONA, V.; BARRA CARACCILO, A. Ecological effects of antibiotics on natural ecosystems: A review. **Microchemical Journal**, v. 136, p. 25–39, 2018.

GROS, M. *et al.* Biodegradation of the X-ray contrast agent iopromide and the fluoroquinolone antibiotic ofloxacin by the white rot fungus *Trametes versicolor* in hospital wastewaters and identification of degradation products. **Water Research**, v. 60, p. 228–241, 2014.

HALLER, L.; HUTTON, G.; BARTRAM, J.. Estimating the costs and health benefits of water and sanitation improvements at global level. **Journal of Water and Health**, v. 5, n. 4, p. 467–480, 2007.

HAROUNE, L. *et al.* Evaluation of the efficiency of *Trametes hirsuta* for the removal of multiple pharmaceutical compounds under low concentrations relevant to the environment. **Bioresource Technology**, v. 171, p. 199–202, 2014.

HATTORI, S. *et al.* *Thermacetogenium phaeum* gen. nov., sp. nov., a strictly anaerobic, thermophilic, syntrophic acetate-oxidizing bacterium. **International Journal of Systematic and Evolutionary Microbiology**, v. 50, n. 4, p. 1601–1609, 2000.

HUNG, G. Y. *et al.* Vincristine exposure impairs skin keratinocytes, ionocytes, and lateral-line hair cells in developing zebrafish embryos. **Aquatic Toxicology**, v. 230, p. 105703, 2021.

IARK, D. *et al.* Enzymatic degradation and detoxification of azo dye Congo red by a new laccase from *Oudemansiella canarii*. **Bioresource Technology**, v. 289, p. 121655, 2019.

INTERNATIONAL AGENCY FOR RESEARCH ON CANCER. **Global Cancer Observatory (GLOBOCAN)**. 2018.

ISIDORI, M. *et al.* Chemical and toxicological characterisation of anticancer drugs in

hospital and municipal wastewaters from Slovenia and Spain. **Environmental Pollution**, v. 219, p. 275–287, 2016.

JIANG, L. *et al.* Butyric acid: Applications and recent advances in its bioproduction. **Biotechnology Advances**, v. 36, n. 8, p. 2101–2117, 2018.

KADU, B. S. *et al.* Degradation of doxorubicin to non-toxic metabolites using Fe-Ni bimetallic nanoparticles. **Chemical Engineering Journal**, v. 325, p. 715–724, 2017.

KAUSHAL, J. *et al.* Catalase enzyme: Application in bioremediation and food industry. **Biocatalysis and Agricultural Biotechnology**, v. 16, p. 192–199, 2018.

KELBERT, M. *et al.* Laccase as an efficacious approach to remove anticancer drugs: A study of doxorubicin degradation, kinetic parameters, and toxicity assessment. **Journal of Hazardous Materials**, v. 409, p. 124520, 2021.

KOSJEK, T. *et al.* Fluorouracil in the environment: Analysis, occurrence, degradation and transformation. **Journal of Chromatography A**, v. 1290, p. 62–72, 2013.

KOSJEK, T.; HEATH, E.. Occurrence, fate and determination of cytostatic pharmaceuticals in the environment. **TrAC - Trends in Analytical Chemistry**, v. 30, n. 7, p. 1065–1087, 2011.

LANGBEHN, Rayane Kunert. **Efeito inibitório da tetraciclina e oxitetraciclina em bactérias nitrificantes e nitrificantes**. 2018. (Mestrado) Programa de Pós- Graduação em Engenharia Química. Universidade Federal de Santa Catarina, Florianópolis-Brasil.

LANGBEHN, R. K.; MICHELS, C.; SOARES, H. M.. Tetracyclines lead to ammonium accumulation during nitrification process. **Journal of Environmental Science and Health**, v. 55, n. 8, p. 1021–1031, 2020.

LATIF, M. A. *et al.* Integrated application of upflow anaerobic sludge blanket reactor for the treatment of wastewaters. **Water Research**, v. 45, n. 16, p. 4683–4699, 2011.

LAVORGNA, M. *et al.* Eco-genotoxicity of six anticancer drugs using comet assay in daphnids. **Journal of Hazardous Materials**, v. 286, p. 573–580, 2015.

LEE, J.; KIM, E.; HWANG, S.. Effects of inhibitions by sodium ion and ammonia and different inocula on acetate-utilizing methanogenesis: Methanogenic activity and succession of methanogens. **Bioresource Technology**, v. 334, p. 125202, 2021.

LEHNINGER, A. L.; NELSON, D. L.; COX, M. M. **Princípios de bioquímica de Lehninger**. 6. ed. ed. Porto Alegre: Artmed, 2014.

LENZ, K. *et al.* Presence of cancerostatic platinum compounds in hospital wastewater and possible elimination by adsorption to activated sludge. **Science of the Total Environment**, v. 345, n. 1–3, p. 141–152, 2005.

LI, D. *et al.* Anticancer drugs in the aquatic ecosystem: Environmental occurrence, ecotoxicological effect and risk assessment. **Environment International**, v. 153, p. 106543, 2021.

LI, W. C. Occurrence, sources, and fate of pharmaceuticals in aquatic environment and soil. **Environmental Pollution**, v. 187, p. 193–201, 2014.

LIANG, J. *et al.* Effects of anaerobic granular sludge towards the treatment of flowback water in an up-flow anaerobic sludge blanket bioreactor: Comparison between mesophilic and thermophilic conditions. **Bioresource Technology**, v. 326, p. 124784, 2021.

LIU, Y. *et al.* Inhibition mitigation and ecological mechanism of mesophilic methanogenesis triggered by supplement of ferroferric oxide in sulfate-containing systems. **Bioresource Technology**, v. 288, p. 121546, 2019.

LLORET, L. *et al.* Laccase-catalyzed degradation of anti-inflammatories and estrogens. **Biochemical Engineering Journal**, v. 51, p. 124–131, 2010.

LÓPEZ-SERNA, R. *et al.* Occurrence of 95 pharmaceuticals and transformation products in urban groundwaters underlying the metropolis of Barcelona, Spain. **Environmental Pollution**, v. 174, p. 305–315, 2013.

LÓPEZ-SERNA, R.; PETROVIĆ, M.; BARCELÓ, D. Occurrence and distribution of multi-class pharmaceuticals and their active metabolites and transformation products in the Ebro River basin (NE Spain). **Science of the Total Environment**, v. 440, p. 280–289, 2012.

LUO, J. *et al.* Potential influences of exogenous pollutants occurred in waste activated sludge on anaerobic digestion: A review. **Journal of Hazardous Materials**, v. 383, p. 121176, 2020.

LUO, Y. *et al.* A review on the occurrence of micropollutants in the aquatic environment and their fate and removal during wastewater treatment. **Science of the Total Environment**, v. 473–474, p. 619–641, 2014.

MAHNIK, S. N. *et al.* Fate of 5-fluorouracil, doxorubicin, epirubicin, and daunorubicin in hospital wastewater and their elimination by activated sludge and treatment in a membrane-bio-reactor system. **Chemosphere**, v. 66, p. 30–37, 2007..

MAI, D. T.; STUCKEY, D. C.; OH, S.. Effect of ciprofloxacin on methane production and anaerobic microbial community. **Bioresource Technology**, v. 261, p. 240–248, 2018.

MAJEAU, J. A.; BRAR, S. K.; TYAGI, R. D.. Laccases for removal of recalcitrant and emerging pollutants. **Bioresource Technology**, v. 101, p. 2331–2350, 2010.

MARTÍN, J. *et al.* Occurrence and Ecotoxicological Risk Assessment of 14 Cytostatic Drugs in Wastewater. **Water, Air, & Soil Pollution**, v. 225, p. 1896, 2014.

MARTÍNEZ, A. T. *et al.* Biodegradation of lignocellulosics: microbial, chemical, and enzymatic aspects of the fungal attack of lignin. **International microbiology : the official journal of the Spanish Society for Microbiology**, v. 8, n. 3, p. 195–204, 2005.

MICHELS, C. *et al.* Silver nanoparticles temporarily retard NO₂ - Production without significantly affecting N₂O release by *Nitrosomonas europaea*. **Environmental Toxicology and Chemistry**, v. 34, n. 10, p. 2231–2235, 2015.

MICHELS, C. **Efeito Inibitório de Nanopartículas de Prata na Atividade de Bactérias Oxidadoras de Amônia**. 2016. (Doutorado) Programa de Pós- Graduação em Engenharia Química. Universidade Federal de Santa Catarina, Florianópolis-Brasil.

MIR-TUTUSAUS, J. A. *et al.* Pharmaceuticals removal and microbial community assessment in a continuous fungal treatment of non-sterile real hospital wastewater after a coagulation-flocculation pretreatment. **Water Research**, v. 116, p. 65–75, 2017.

MIR-TUTUSAUS, J. A.; SARRÀ, M.; CAMINAL, G. Continuous treatment of non-sterile hospital wastewater by *Trametes versicolor*: How to increase fungal viability by means of operational strategies and pretreatments. **Journal of Hazardous Materials**, v. 318, p. 561–570, 2016.

MOGHARABI, M.; FARAMARZI, M. A.. Laccase and laccase-mediated systems in the synthesis of organic compounds. **Advanced Synthesis and Catalysis**, v. 356, p. 897–927, 2014.

MORSI, R. *et al.* Laccases and peroxidases: The smart, greener and futuristic biocatalytic tools to mitigate recalcitrant emerging pollutants. **Science of the Total**

Environment, [S v. 714, p. 136572, 2020.

MUÑOZ SIERRA, J. D. *et al.* Comparative performance of upflow anaerobic sludge blanket reactor and anaerobic membrane bioreactor treating phenolic wastewater: Overcoming high salinity. **Chemical Engineering Journal**, [S. v. 366, p. 480–490, 2019.

NAGHDI, M. *et al.* Removal of pharmaceutical compounds in water and wastewater using fungal oxidoreductase enzymes. **Environmental Pollution**, v. 234, p. 190–213, 2018 a.

NAGHDI, M. *et al.* Biotransformation of carbamazepine by laccase-mediator system: Kinetics, by-products and toxicity assessment. **Process Biochemistry**, v. 67, p. 147–154, 2018 b.

NEGREIRA, N. *et al.* Multianalyte determination of 24 cytostatics and metabolites by liquid chromatography-electrospray-tandem mass spectrometry and study of their stability and optimum storage conditions in aqueous solution. **Talanta**, v. 116, p. 290–299, 2013.

NEGREIRA, N. *et al.* Transformation of tamoxifen and its major metabolites during water chlorination: Identification and in silico toxicity assessment of their disinfection byproducts. **Water Research**, v. 85, p. 199–207, 2015 a.

NEGREIRA, N. *et al.* Degradation of the anticancer drug erlotinib during water chlorination: Non-targeted approach for the identification of transformation products. **Water Research**, v. 85, p. 103–113, 2015 b.

NEGREIRA, N.; DE ALDA, M. L.; BARCELÓ, D.. Cytostatic drugs and metabolites in municipal and hospital wastewaters in Spain: Filtration, occurrence, and environmental risk. **Science of the Total Environment**, v. 497–498, p. 68–77, 2014.

NEGREIRA, N.; LÓPEZ DE ALDA, M.; BARCELÓ, D. On-line solid phase extraction-liquid chromatography-tandem mass spectrometry for the determination of 17 cytostatics and metabolites in waste, surface and ground water samples. **Journal of Chromatography A**, v. 1280, p. 64–74, 2013.

NOBU, M. K. *et al.* Microbial dark matter ecogenomics reveals complex synergistic networks in a methanogenic bioreactor. **The ISME Journal** v. 9, n. 8, p. 1710–1722, 2015.

NORMAN. **Network of reference laboratories, research centres and related organisations for monitoring of emerging environmental substances**. 2016. Available in: <https://www.norman-network.com/?q=node/19>.

NOVOTNA, R. *et al.* Inactivation of the anticancer drugs doxorubicin and oracin by aldo-keto: Reductase (AKR) 1C3. **Toxicology Letters**, v. 181, p. 1–6, 2008.

NUSSBAUMER, S. *et al.* Analysis of anticancer drugs: A review. **Talanta**, v. 85, p. 2265–2289, 2011.

OLALLA, A. *et al.* A case study to identify priority cytostatic contaminants in hospital effluents. **Chemosphere**, v. 190, p. 417–430, 2018.

OSMA, J. F.; TOCA-HERRERA, J. L.; RODRÍGUEZ-COUTO, S. Transformation pathway of Remazol Brilliant Blue R by immobilised laccase. **Bioresource Technology**, v. 101, p. 8509–8514, 2010.

PALVANNAN, T. *et al.* Efficient transformation of phenyl urea herbicide chloroxuron by laccase immobilized on zein polyurethane nanofiber. **Journal of Molecular Catalysis B: Enzymatic**, v. 99, p. 156–162, 2014.

PERAZZOLI, SIMONE. **Avaliação do efeito das nanopartículas de óxido de ferro sobre uma comunidade de bactérias oxidadores de amônia (BOAs)**. 2015. (Mestrado) Programa de Pós- Graduação em Engenharia Química. Universidade Federal de Santa Catarina, Florianópolis-Brasil.

PEREIRA, C. S. *et al.* Potential of enzymatic process as an innovative technology to remove anticancer drugs in wastewater. **Applied Microbiology and Biotechnology**, v. 104, p. 23–31, 2020.

PEREIRA, Camila Senna. **Enzymatic process as a potential treatment technology to remove anticancer drugs from wastewater: Laccase-assisted degradation of etoposide**. 2020. (Mestrado) Programa de Pós- Graduação em Engenharia Química. Universidade Federal de Santa Catarina, Florianópolis-Brasil..

PIERRE, H.; MAUD, V.; BENOÎT, M.. Determination of sorption properties of micropollutants: What is the most suitable activated sludge inhibition technique to preserve the biomass structure? **Chemical Engineering Journal**, v. 242, p. 260–268, 2014.

PONCE-ROBLES, L. *et al.* Practical approach to the evaluation of industrial wastewater treatment by the application of advanced microbiological techniques. **Ecotoxicology and Environmental Safety**, v. 166, n. September, p. 123–131, 2018.

PRIETO, A. *et al.* Degradation of the antibiotics norfloxacin and ciprofloxacin by a

white-rot fungus and identification of degradation products. **Bioresource Technology**, v. 102, n. 23, p. 10987–10995, 2011.

PROTEIN DATA BANK (PDB ID: 1KYA). **1KYA - Active laccase from *Trametes versicolor* complexed with 2,5-xylydine.** 2002. Available in: <https://doi.org/10.1093/bioinformatics/bty419>.

QUEIRÓS, V. *et al.* The antineoplastic drugs cyclophosphamide and cisplatin in the aquatic environment – Review. **Journal of Hazardous Materials**, v. 412, p. 125028, 2021.

RAHMANI, K. *et al.* Elimination and detoxification of sulfathiazole and sulfamethoxazole assisted by laccase immobilized on porous silica beads. **International Biodeterioration and Biodegradation**, v. 97, p. 107–114, 2015.

REYES-CONTRERAS, C.; VIDAL, Gladys. Methanogenic toxicity evaluation of chlortetracycline hydrochloride. **Electronic Journal of Biotechnology**, v. 18, n. 6, p. 445–450, 2015.

RIVERA-HOYOS, C. M. *et al.* Fungal laccases. **Fungal Biology Reviews**, v. 27, p. 67–82, 2013.

RODARTE-MORALES, A. I. *et al.* Degradation of selected pharmaceutical and personal care products (PPCPs) by white-rot fungi. **World Journal of Microbiology and Biotechnology**, v. 27, n. 8, p. 1839–1846, 2011.

RODRIGUEZ-NARVAEZ, O. M. *et al.* Treatment technologies for emerging contaminants in water: A review. **Chemical Engineering Journal**, v. 323, p. 361–380, 2017.

ROOPNARAIN, A. *et al.* Unravelling the anaerobic digestion ‘black box’: Biotechnological approaches for process optimization. **Renewable and Sustainable Energy Reviews**, v. 152, p. 111717, 2021.

ROSER, M.; RITCHIE, H. Cancer. **Our World in Data**, 2018.

SANTANA-VIERA, S. *et al.* Cytostatic drugs in environmental samples: An update on the extraction and determination procedures. **Trends in Analytical Chemistry**, v. 80, p. 373–386, 2016.

SANTANA-VIERA, S. *et al.* Simultaneous and systematic analysis of cytostatic drugs in wastewater samples by ultra-high performance liquid chromatography tandem mass spectrometry. **Journal of Chromatography B**, v. 1110–1111, p. 124–132, 2019.

SENTHIVELAN, T.; KANAGARAJ, J.; PANDA, R. C. Recent trends in fungal laccase for various industrial applications: An eco-friendly approach - A review. **Biotechnology and Bioprocess Engineering**, v. 21, n. 1, p. 19–38, 2016.

SHEN, L. *et al.* Interspecies electron transfer in syntrophic methanogenic consortia: From cultures to bioreactors. **Renewable and Sustainable Energy Reviews**, v. 54, p. 1358–1367, 2016.

SHI, X.; LEONG, Kwok Yii; NG, How Yong. Anaerobic treatment of pharmaceutical wastewater: A critical review. **Bioresource Technology**, v. 245, n. July, p. 1238–1244, 2017.

SILVA, S. A. *et al.* Toxicity of long chain fatty acids towards acetate conversion by *Methanosaeta concilii* and *Methanosarcina mazei*. **Microbial Biotechnology**, v. 9, n. 4, p. 514–518, 2016.

SIMÓN-HERRERO, C. *et al.* Immobilized laccase on polyimide aerogels for removal of carbamazepine. **Journal of Hazardous Materials**, v. 376, n. April, p. 83–90, 2019.

SPERANZA, M. *et al.* Biodegradation of lignocellulosics : microbial, chemical, and enzymatic aspects of the fungal attack of lignin. **International Microbiology**, v. 8, n. 3, p. 195–204, 2005.

STARLING, M. C. V. M.; AMORIM, C. C.; LEÃO, M. M. D. Occurrence, control and fate of contaminants of emerging concern in environmental compartments in Brazil. **Journal of Hazardous Materials**, v. 372, p. 0–1, 2018.

STEINMETZ, R. L. R. **Avaliação do Efeito de Drogas Veterinárias na Produção Específica de Biogás de Substratos Agropecuárias**. 2016. (Brasil) Programa de Pós-Graduação em Engenharia Química. Universidade Federal de Santa Catarina, Florianópolis-Brasil.

SZEKERES, E. *et al.* Abundance of antibiotics, antibiotic resistance genes and bacterial community composition in wastewater effluents from different Romanian hospitals. **Environmental Pollution**, v. 225, p. 304–315, 2017.

TABOADA-SANTOS, A. *et al.* Thermal hydrolysis of sewage sludge partially removes organic micropollutants but does not enhance their anaerobic biotransformation. **Science of the Total Environment**, v. 690, p. 534–542, 2019.

TABOADA-SANTOS, A. *et al.* Assessment of the fate of organic micropollutants in

novel wastewater treatment plant configurations through an empirical mechanistic model. **Science of the Total Environment**, v. 716, p. 137079, 2020.

TAHERAN, M. *et al.* Emerging contaminants: Here today, there tomorrow! **Environmental Nanotechnology, Monitoring and Management**, [S. l.], v. 10, p. 122–126, 2018.

TANG, Y. *et al.* Administration of probiotic mixture DM#1 ameliorated 5-fluorouracil-induced intestinal mucositis and dysbiosis in rats. **Nutrition**, v. 33, p. 96–104, 2017.

TEODOSIU, C. *et al.* Emerging pollutants removal through advanced drinking water treatment: A review on processes and environmental performances assessment. **Journal of Cleaner Production**, v. 197, p. 1210–1221, 2018.

TERNES, T. A. *et al.* Methods for the determination of neutral drugs as well as betablockers and β 2-sympathomimetics in aqueous matrices using GC/MS and LC/MS/MS. **Fresenius' Journal of Analytical Chemistry**, [S. l.], v. 362, n. 3, p. 329–340, 1998.

TERNES, T. A.; JOSS, Adriano; SIEGRIST, Hansruedi. Scrutinizing pharmaceuticals and personal care products in wastewater treatment. **Environmental Science and Technology**, v. 38, n. 20, 2004.

TORRE, L. A. *et al.* Global Cancer Statistics, 2012. **CA: a cancer journal of clinicians.**, v. 65, n. 2, p. 87–108, 2015.

TOWN, J. R. *et al.* Molecular characterization of anaerobic digester microbial communities identifies microorganisms that correlate to reactor performance. **Bioresource Technology**, v. 151, p. 249–257, 2014.

UNUOFIN, J. O.; OKOH, A. I.; NWODO, U. U. Recovery of laccase-producing gammaproteobacteria from wastewater. **Biotechnology Reports**, v. 21, p. e00320, 2019.

VARGA, B. *et al.* Enzymatic treatment and subsequent toxicity of organic micropollutants using oxidoreductases - A review. **Journal of Cleaner Production**, v. 221, p. 306–322, 2019.

VERLICCHI, P. *et al.* Hospital effluent: Investigation of the concentrations and distribution of pharmaceuticals and environmental risk assessment. **Science of the Total Environment**, v. 430, p. 109–118, 2012.

VERLICCHI, P.; AL AUKIDY, M.; ZAMBELLO, E. Occurrence of pharmaceutical compounds in urban wastewater: Removal, mass load and environmental risk after a secondary treatment-A review. **Science of the Total Environment**, v. 429, p. 123–155, 2012.

VIANA, A. T. *et al.* Environmental superbugs: The case study of *Pedobacter spp.* **Environmental Pollution**, v. 241, p. 1048–1055, 2018.

VYAS, N.; TURNER, A.; SEWELL, G. Platinum-based anticancer drugs in waste waters of a major UK hospital and predicted concentrations in recipient surface waters. **Science of the Total Environment**, v. 493, p. 324–329, 2014.

WANG, H. L. *et al.* Effect of arsanilic acid on anaerobic methanogenic process: Kinetics, inhibition and biotransformation analysis. **Biochemical Engineering Journal**, v. 91, p. 179–185, 2014.

WANG, X. *et al.* Removal of cytostatic drugs from wastewater by an anaerobic osmotic membrane bioreactor. **Chemical Engineering Journal**, v. 339, p. 153–161, 2018.

WANG, Y.; QIAN, P. Y. Conservative fragments in bacterial 16S rRNA genes and primer design for 16S ribosomal DNA amplicons in metagenomic studies. **PLoS ONE**, v. 4, n. 10, 2009.

WESTMAN, E. L. *et al.* Bacterial inactivation of the anticancer drug doxorubicin. **Cell press Chemistry and Biology**, v. 19, p. 1255–1264, 2012.

WILKIE, A.C.; RIEDESEL, K. J.; OWENS, J. M. S. Characterization and anaerobic treatment of ethanol stillage from conventional and cellulosic feedstocks. **Biomass and Bioenergy**, v. 19, n. 2, p. 63–102, 2000.

WILKINSON, J. *et al.* Occurrence, fate and transformation of emerging contaminants in water: An overarching review of the field. **Environmental Pollution**, v. 231, p. 954–970, 2017.

WORLD HEALTH ORGANIZATION. **Guidelines for Drinking-water Quality**. Fourth ed. Geneva: World Health Organization. 2017. *E-book*. Available in: [https://doi.org/10.1016/S1462-0758\(00\)00006-6](https://doi.org/10.1016/S1462-0758(00)00006-6)

WORLD HEALTH ORGANIZATION. **World Health Organisation Water, Sanitation and Hygiene: Strategy 2018-2025**. Geneva, Switzerland. 2018.

WU, Y. *et al.* Metagenomic insights into the influence of salinity and cytostatic drugs on the composition and functional genes of microbial community in forward osmosis anaerobic membrane bioreactors. **Chemical Engineering Journal**, v. 326, p. 462–469, 2017.

XU, F. Oxidation of phenols, anilines, and benzenethiols by fungal laccases: Correlation between activity and redox potentials as well as halide inhibition. **Biochemistry**, v. 35, p. 7608–7614, 1996.

XU, F. Effects of redox potential and hydroxide inhibition on the pH activity profile of fungal laccases. **Journal of Biological Chemistry**, v. 272, p. 924–928, 1997.

YADAV, A. *et al.* Threat and sustainable technological solution for antineoplastic drugs pollution: Review on a persisting global issue. **Chemosphere**, p. 128285, 2020.

YANG, J. *et al.* Degradation of tetracycline by immobilized laccase and the proposed transformation pathway. **Journal of Hazardous Materials**, v. 322, p. 525–531, 2017.

YANG, Y. *et al.* Metagenomic analysis of sludge from full-scale anaerobic digesters operated in municipal wastewater treatment plants. **Applied Microbiology and Biotechnology**, v. 98, n. 12, p. 5709–5718, 2014.

YANG, Y.; ZHANG, C.; HU, Z. Impact of metallic and metal oxide nanoparticles on wastewater treatment and anaerobic digestion. **Environmental Science: Processes & Impacts**, v. 15, p. 39–48, 2013.

YIN, J. *et al.* A preliminary study on the occurrence of cytostatic drugs in hospital effluents in Beijing, China. **Bulletin of Environmental Contamination and Toxicology**, v. 84, p. 39–45, 2010.

ZAIDI, S. A. Molecular Imprinting Prevents Environmental Contamination and Body Toxicity from Anticancer Drugs: An Update. **Critical Reviews in Analytical Chemistry**, v. 49, n. 4, p. 324–335, 2019.

ZDARTA, J. *et al.* A promising laccase immobilization using electrospun materials for biocatalytic degradation of tetracycline: Effect of process conditions and catalytic pathways. **Catalysis Today**, v. 348, p. 127–136, 2020.

ZDARTA, J. *et al.* Free and immobilized biocatalysts for removing micropollutants from water and wastewater: Recent progress and challenges. **Bioresource Technology**, v. 344, p. 126201, 2022.

ZEIKUS, J. G. The biology of methanogenic bacteria. **Bacteriological Reviews**, v. 41, n. 2, p. 514–541, 1977.

ZHANG, C. *et al.* An effective in-situ method for laccase immobilization: Excellent activity, effective antibiotic removal rate and low potential ecological risk for degradation products. **Bioresource Technology**, v. 308, p. 123271, 2020.

ZHANG, J. *et al.* Removal of cytostatic drugs from aquatic environment: A review. **Science of the Total Environment**, v. 445–446, p. 281–298, 2013.

ZHANG, L. *et al.* Functional bacterial and archaeal dynamics dictated by pH stress during sugar refinery wastewater in a UASB. **Bioresource Technology**, v. 288, p. 121464, 2019..

ZHANG, W. *et al.* Free acetic acid as the key factor for the inhibition of hydrogenotrophic methanogenesis in mesophilic mixed culture fermentation. **Bioresource Technology**, v. 264, n. March, p. 17–23, 2018.

ZINDER, S. H. *et al.* Methanogenesis in a thermophilic ad, methanotrix sp as an important aceticlastic methanogen.pdf. **Applied and environmental microbiology**, v. 47, n. 4, p. 796–807, 1984.

ZOUNKOVÁ, R. *et al.* Ecotoxicity and genotoxicity assessment of cytostatic pharmaceuticals. **Environmental Toxicology and Chemistry**, v. 26, n. 10, p. 2208–2214, 2007.

SUPPLEMENTARY MATERIAL

CHAPTER 3 - SUPPLEMENTARY MATERIAL

Figure S1. Illustrative scheme of the reactor used for acclimatization of the biomass used in the experiments. (A) represents the feed medium, (B) peristaltic pump, (C) reactor feed input, (D) output for the removal of biomass to carry out the experiments, (E) input and output of the reactor heating jacket, (F) three-phase separator, (G) reactor liquid outlet, (H) breather bottle and (I) gas meter.

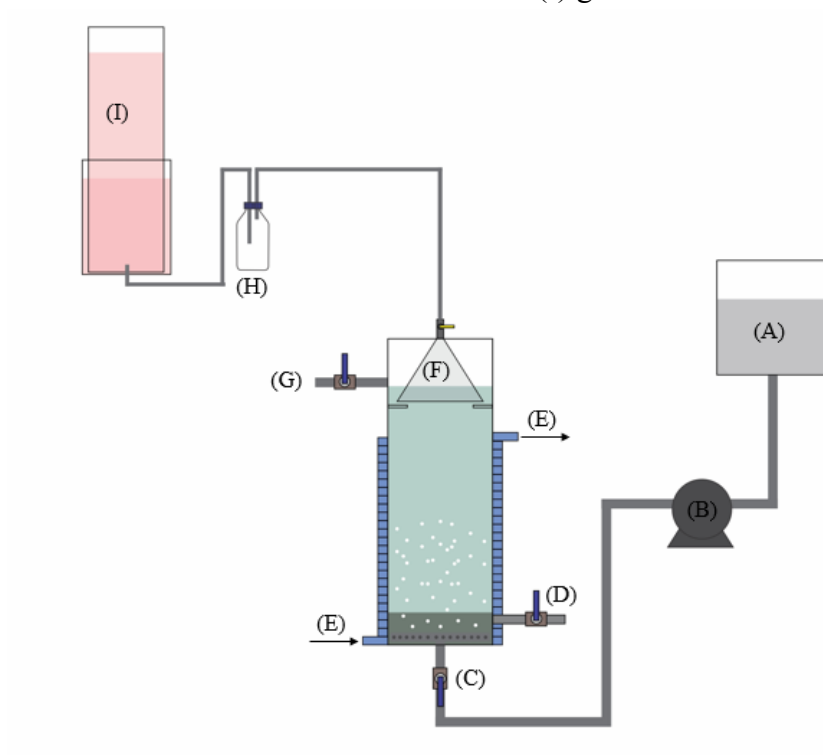

Figure S2. Monitoring of biogas production and biomass acclimatization reactor pH

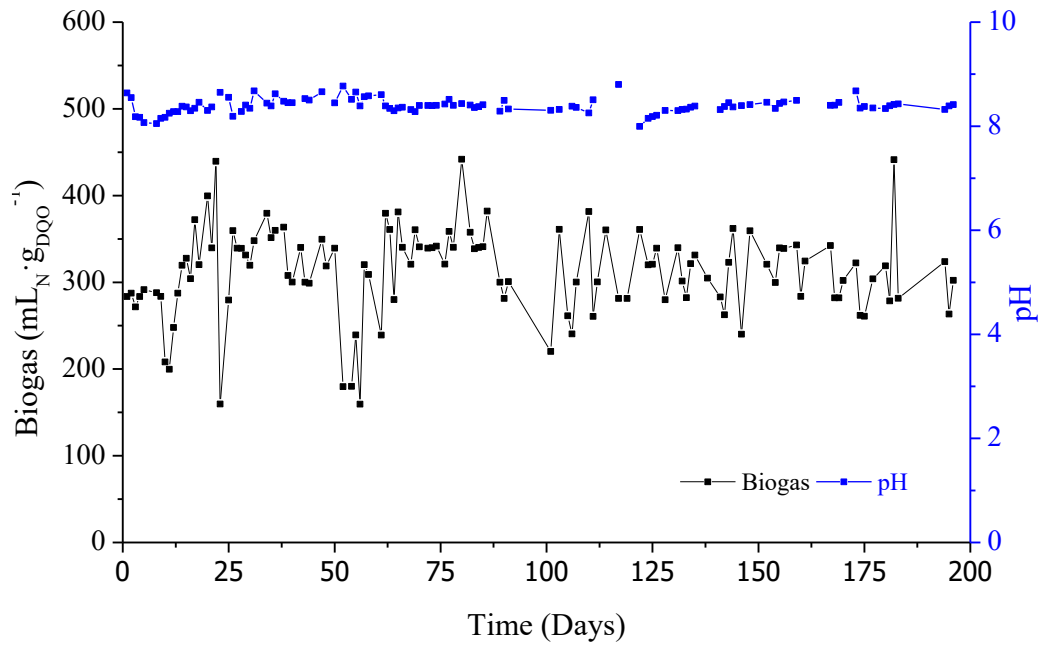

Table S1. Composition of biogas produced by the biomass stabilization reactor

Day	Composition (%)			
	CH ₄	CO ₂	O ₂	BAL
47	94.2	5.3	0.4	0.1
52	90.3	5.2	0.4	4.1
89	78.8	3.9	2.9	14.4
103	84.9	5.0	0.9	9.2
112	87.2	5.1	1.0	6.7
119	80.1	2.0	3.0	14.9
124	83.6	6.2	1.5	8.7
155	88.8	3.3	1.3	6.6

Figure S3. Calibration line for the quantification of DOX

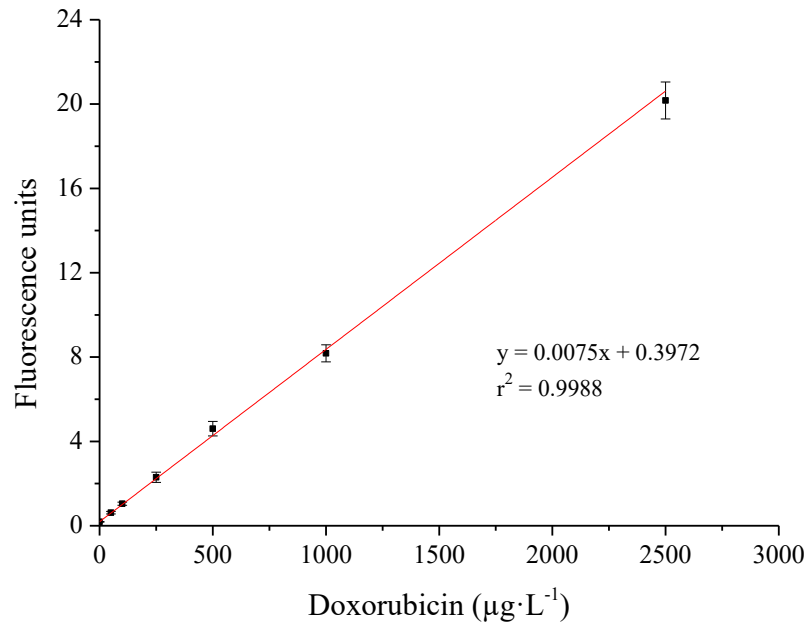
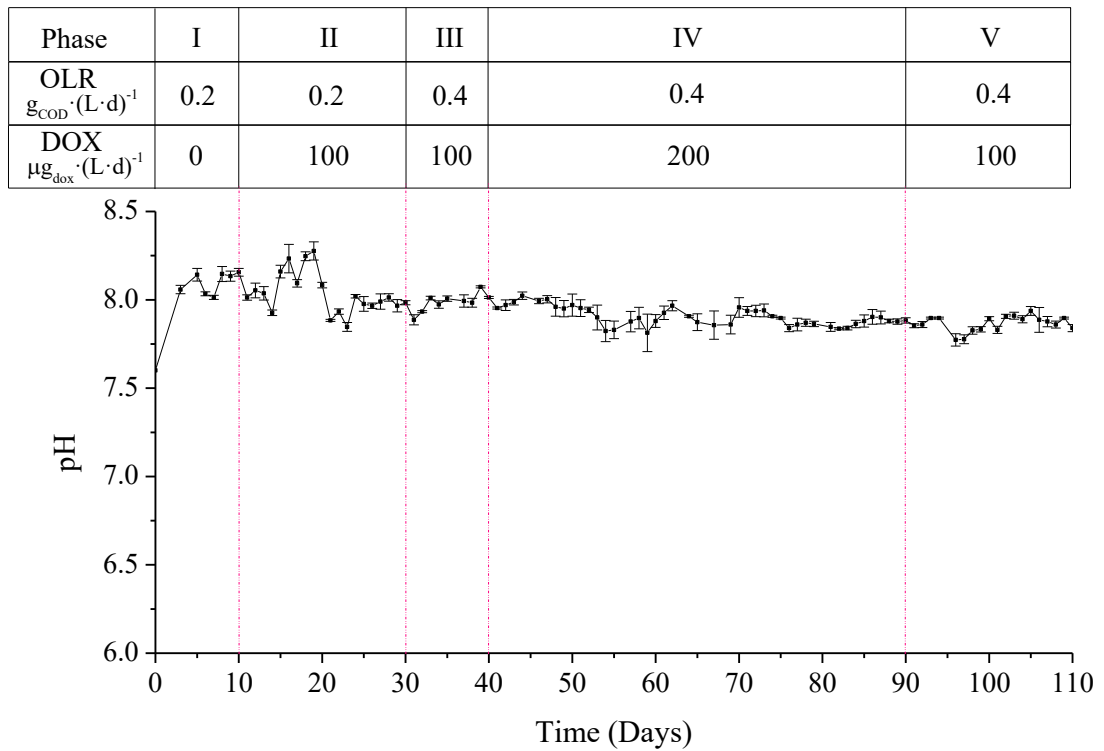

Figure S4. Values of pH in the effluent of the reactor during the log-term exposure assay to doxorubicin.



CHAPTER 4 - SUPPLEMENTARY MATERIAL

Figure S5. Calibration line made in different pH values for the quantification of DOX.
A) pH 3, B) pH 4, C) pH 5, D) pH 6, E) pH 7 and F) pH 8.

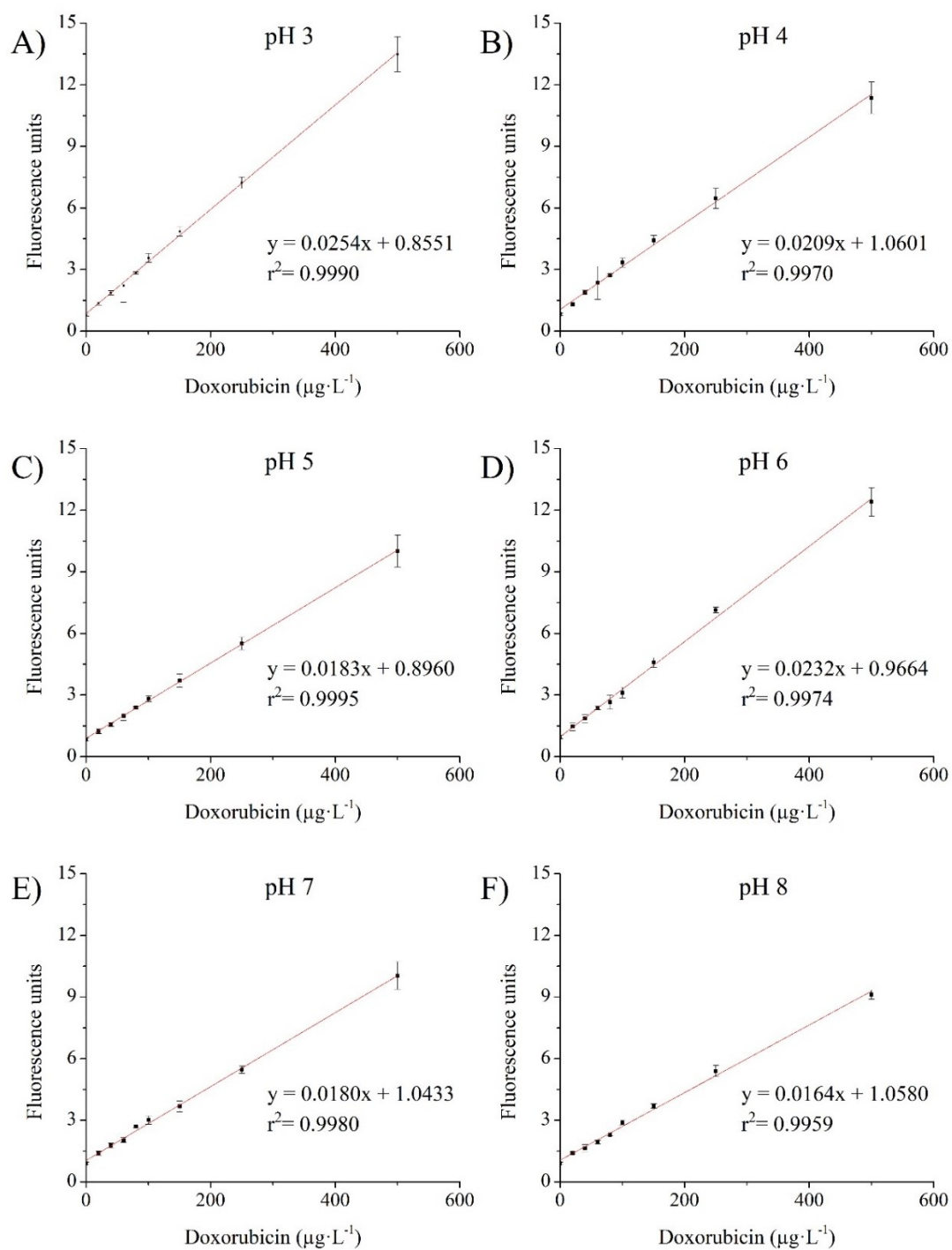

Figure S6. Calibration line for quantification of DOX, used in the experiments to determine Michaelis-Menten kinetic parameters.

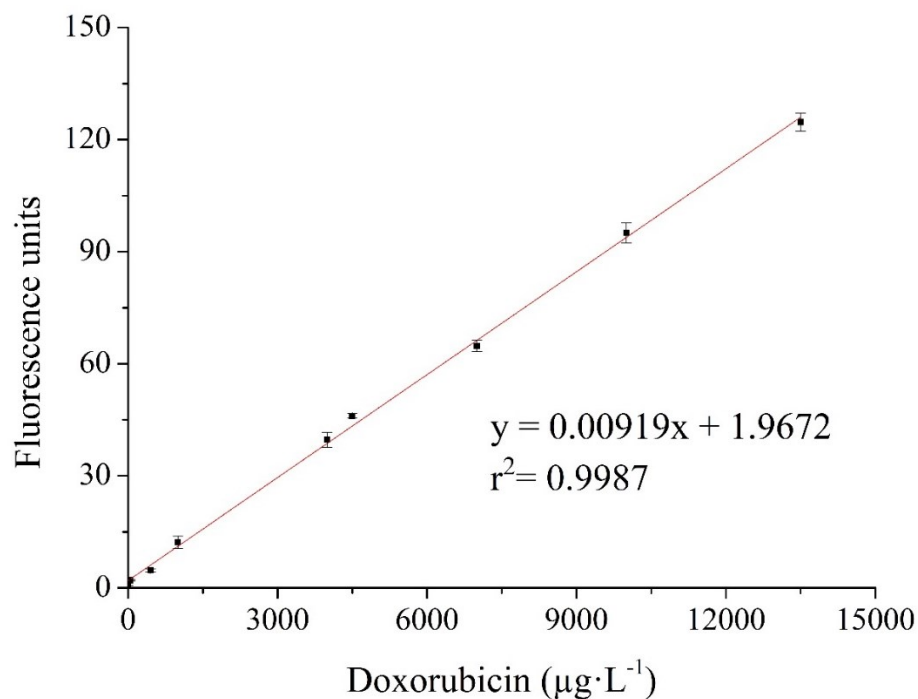

Figure S7. Control experiments of DOX without the presence of LC in different pH values. All control experiments were carried out at 30 °C, with 250 $\mu\text{g}\cdot\text{L}^{-1}$ of DOX.

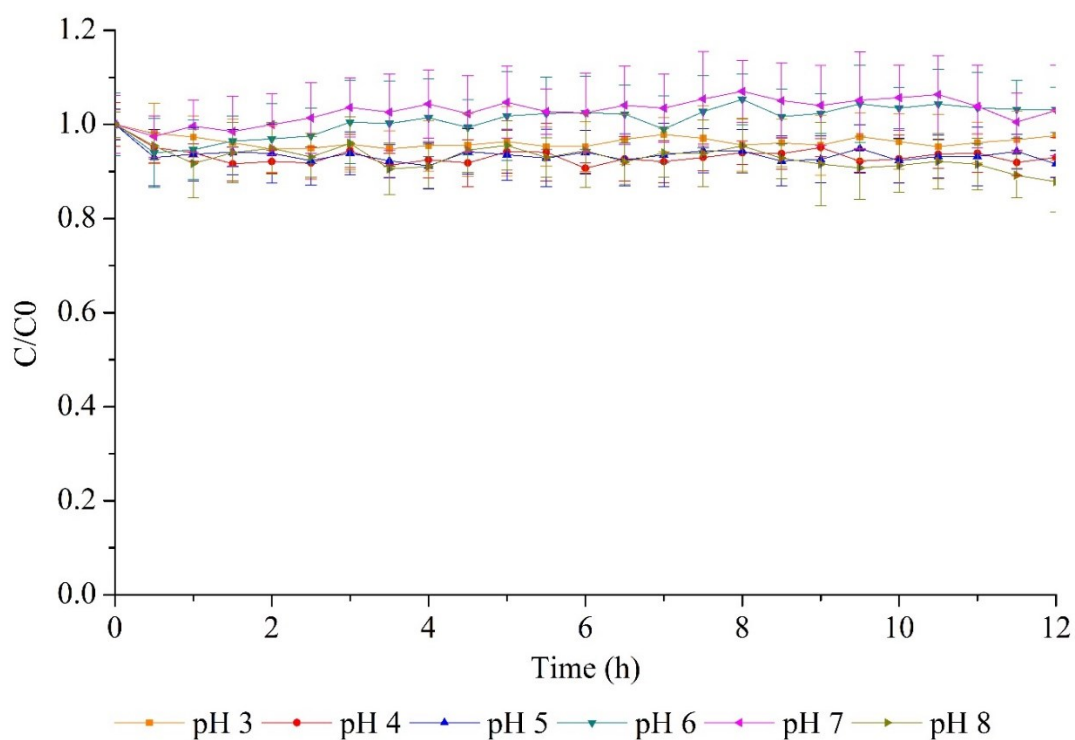

Figure S8. Stability of DOX in different temperatures. All control experiments were carried out without LC, at pH 7 and with $250 \mu\text{g}\cdot\text{L}^{-1}$ of DOX.

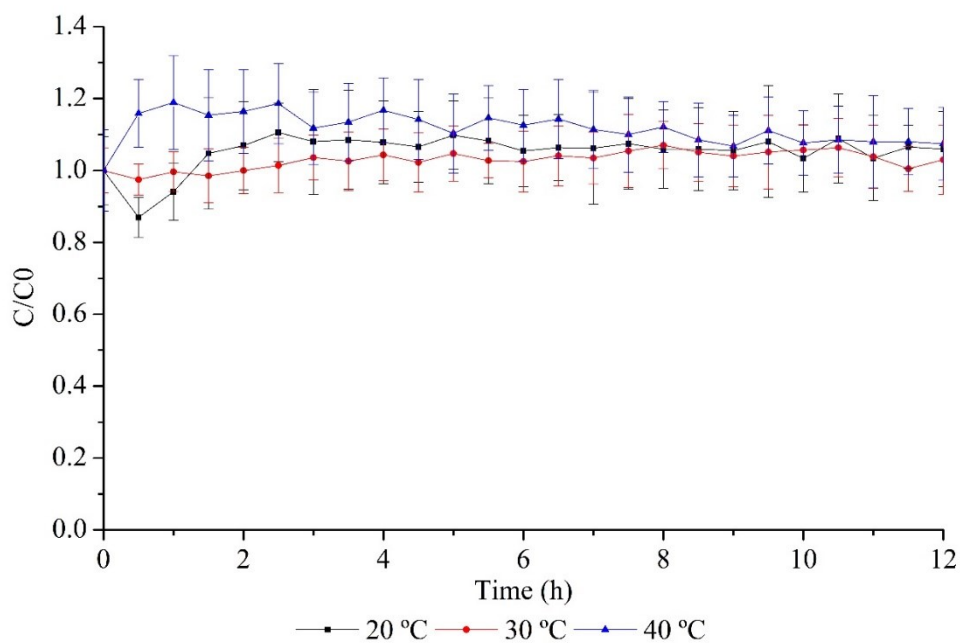

Figure S9. Stability of different DOX concentrations. All control experiments were carried out without LC, at 30 °C and pH 7

